

Industrial Automation Headquarters

Delta Electronics, Inc.
Taoyuan Technology Center
No.18, Xinglong Rd., Taoyuan District,
Taoyuan City 33068, Taiwan
TEL: 886-3-362-6301 / FAX: 886-3-371-6301

Asia

Delta Electronics (Shanghai) Co., Ltd.
No.182 Minyu Rd., Pudong Shanghai, P.R.C.
Post code : 201209
TEL: 86-21-6872-3988 / FAX: 86-21-6872-3996
Customer Service: 400-820-9595

Delta Electronics (Japan), Inc.
Tokyo Office
Industrial Automation Sales Department
2-1-14 Shibadaimon, Minato-ku
Tokyo, Japan 105-0012
TEL: 81-3-5733-1155 / FAX: 81-3-5733-1255

Delta Electronics (Korea), Inc.
Seoul Office
1511, 219, Gasan Digital 1-Ro., Geumcheon-gu,
Seoul, 08501 South Korea
TEL: 82-2-515-5305 / FAX: 82-2-515-5302

Delta Energy Systems (Singapore) Pte Ltd.
4 Kaki Bukit Avenue 1, #05-04, Singapore 417939
TEL: 65-6747-5155 / FAX: 65-6744-9228

Delta Electronics (India) Pvt. Ltd.
Plot No.43, Sector 35, HSIIDC Gurgaon,
PIN 122001, Haryana, India
TEL: 91-124-4874900 / FAX : 91-124-4874945

Delta Electronics (Thailand) PCL.
909 Soi 9, Moo 4, Bangpoo Industrial Estate (E.P.Z),
Pattana 1 Rd., T.Phraksa, A.Muang,
Samutprakarn 10280, Thailand
TEL: 66-2709-2800 / FAX : 662-709-2827

Delta Electronics (Australia) Pty Ltd.
Unit 20-21/45 Normanby Rd., Notting Hill Vic 3168, Australia
TEL: 61-3-9543-3720

Americas

Delta Electronics (Americas) Ltd.
Raleigh Office
P.O. Box 12173, 5101 Davis Drive,
Research Triangle Park, NC 27709, U.S.A.
TEL: 1-919-767-3813 / FAX: 1-919-767-3969

Delta Greentech (Brasil) S/A
São Paulo Office
Rua Itapeva, 26 – 3º Andar - Bela Vista
CEP: 01332-000 – São Paulo – SP - Brasil
TEL: 55-11-3530-8643 / 55-11-3530-8640

Delta Electronics International Mexico S.A. de C.V.
Mexico Office
Gustavo Baz No. 309 Edificio E PB 103
Colonia La Loma, CP 54060
Tlalnepantla, Estado de México
TEL: 52-55-3603-9200

EMEA

Headquarters: Delta Electronics (Netherlands) B.V.
Sales: Sales.IA.EMEA@deltaww.com
Marketing: Marketing.IA.EMEA@deltaww.com
Technical Support: iatechnicalsupport@deltaww.com
Customer Support: Customer-Support@deltaww.com
Service: Service.IA.emea@deltaww.com
TEL: +31(0)40 800 3900

BENELUX: Delta Electronics (Netherlands) B.V.
De Witbogt 20, 5652 AG Eindhoven, The Netherlands
Mail: Sales.IA.Benelux@deltaww.com
TEL: +31(0)40 800 3900

DACH: Delta Electronics (Netherlands) B.V.
Coesterweg 45, D-59494 Soest, Germany
Mail: Sales.IA.DACH@deltaww.com
TEL: +49(0)2921 987 0

France: Delta Electronics (France) S.A.
ZI du bois Challand 2, 15 rue des Pyrénées,
Lisses, 91090 Evry Cedex, France
Mail: Sales.IA.FR@deltaww.com
TEL: +33(0)1 69 77 82 60

Iberia: Delta Electronics Solutions (Spain) S.L.U
Ctra. De Villaverde a Vallecas, 265 1º Dcha Ed.
Hormigueras – P.I. de Vallecas 28031 Madrid
TEL: +34(0)91 223 74 20

Carrer Llacuna 166, 08018 Barcelona, Spain
Mail: Sales.IA.Iberia@deltaww.com

Italy: Delta Electronics (Italy) S.r.l.
Via Meda 2–22060 Novedrate(CO)
Piazza Grazioli 18 00186 Roma Italy
Mail: Sales.IA.Italy@deltaww.com
TEL: +39 039 8900365

Russia: Delta Energy System LLC
Vereyskaya Plaza II, office 112 Vereyskaya str.
17 121357 Moscow Russia
Mail: Sales.IA.RU@deltaww.com
TEL: +7 495 644 3240

Turkey: Delta Greentech Elektronik San. Ltd. Sti. (Turkey)
Şerifali Mah. Hendem Cad. Kule Sok. No:16-A
34775 Ümraniye – İstanbul
Mail: Sales.IA.Turkey@deltaww.com
TEL: + 90 216 499 9910

GCC: Delta Energy Systems AG (Dubai BR)
P.O. Box 185668, Gate 7, 3rd Floor, Hamarain Centre
Dubai, United Arab Emirates
Mail: Sales.IA.MEA@deltaww.com
TEL: +971(0)4 2690148

Egypt + North Africa: Delta Electronics
Unit 318, 3rd Floor, Trivium Business Complex, North 90 street,
New Cairo, Cairo, Egypt
Mail: Sales.IA.MEA@deltaww.com

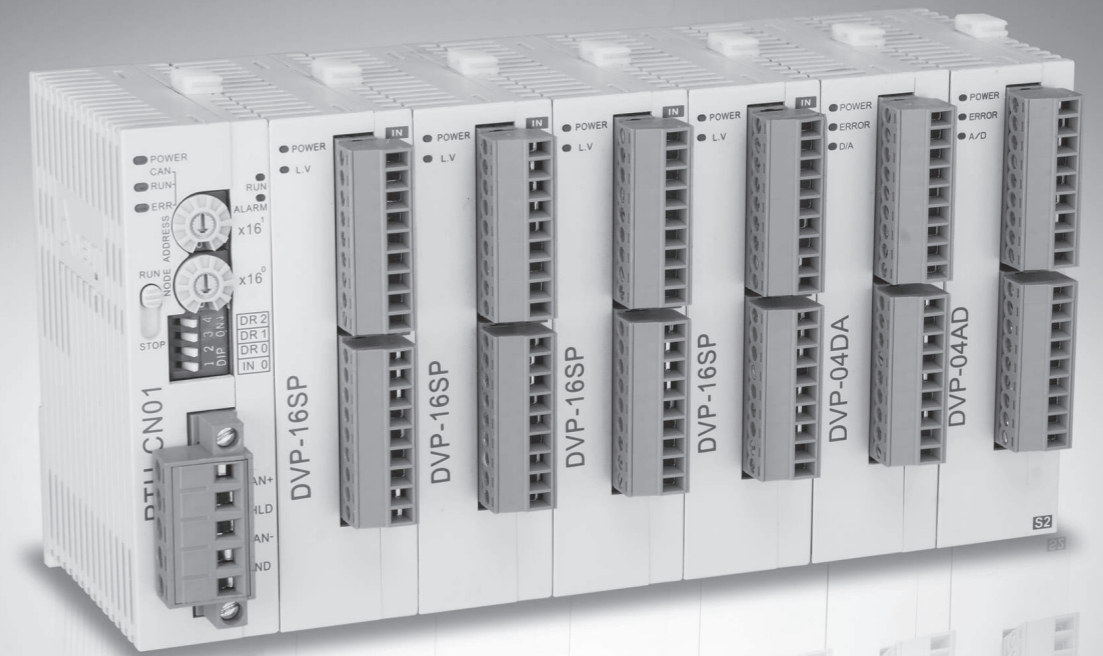

RTU-CN01 CANopen Remote IO Communication Module Operation Manual

RTU-CN01 Operation Manual

Table of Contents

Chapter 1 Preface	1-1
1.1 Explanation of Symbols in This Manual	1-2
1.2 Revision History	1-2
Chapter 2 Overview	2-1
2.1 Characteristics	2-2
2.2 Supported CANopen Services	2-2
2.3 Specifications	2-3
2.4 Extension Modules Connectable to RTU-CN01	2-4
Chapter 3 Profile and Parts	3-1
3.1 Profile and Dimension	3-2
3.2 Parts	3-2
3.3 CANopen Port	3-3
3.4 RUN/STOP Switch	3-3
3.5 Address Switches	3-3
3.6 Function Switch	3-4
3.7 IO Extension Interface	3-4
Chapter 4 Installing and Wiring	4-1
4.1 Installing RTU-CN01 and DVP-S Extension Modules	4-2
4.2 Installing RTU-CN01 and DVP-S Modules on DIN Rail	4-2
4.3 Connecting to CANopen Bus	4-3
4.3.1 Connecting to CANopen Port	4-3
4.3.2 CANopen Network Topology	4-3
4.3.3 Connecting to CANopen Port	4-3
4.4 Wiring	4-4
4.4.1 Power Input	4-4
4.4.2 Ground	4-5
Chapter 5 Configuring RTU-CN01	5-1
5.1 Terms	5-2
5.2 Introduction to the Software Interfaces	5-3
5.2.1 RTU Setting tab	5-6
5.2.2 "RTU Setup" Interface	5-6
5.2.3 Control Word and Status Word in RTU-CN01	5-8
5.2.4 "Special Module Configuration" Interface	5-10
5.2.5 The Interface for Configuring Digital Modules	5-13
5.2.6 "RTU IO Mapping" Interface	5-15
5.3 CANopen IO Mapping	5-15
5.3.1 IO Data Mapping	5-15
5.3.2 PDO Mapping	5-18

5.3.3 Adding RTU-CN01 Configuration to Node Configuration List.....	5-20
Chapter 6 Introduction of Parameters and PDO Transmission Types	6-1
6.1 Parameters from EDS File	6-2
6.2 PDO Transmission Types	6-8
Chapter 7 Application Examples	7-1
7.1 Configuring RTU-CN01 Parameters via CANopen Builder	7-3
7.1.1 Configuring RTU-CN01 Module	7-3
7.1.2 Downloading Configuration to CANopen Master	7-9
7.1.3 Program Control over RTU-CN01 in the CANopen Network	7-11
7.2 Example of Using RTU-CN01 with Non-Delta Master Together ...	7-14
7.2.1 Setting Baud Rate.....	7-14
7.2.2 Importing EDS File of RTU-CN01	7-16
7.2.3 Adding the Remote Terminal RTU-CN01	7-16
7.2.4 Configuring CANopen Remote Device Parameters	7-19
7.2.5 Configuring PDO Mappings.....	7-19
Chapter 8 Error Diagnosis and Trouble-shooting	8-1
8.1 LED Indicator Diagnosis	8-2
8.2 Status Word Diagnosis	8-3
8.3 Software Diagnosis	8-5
Appendix A List of Accessories	A-1
A.1 Accessories for CANopen Communication	A-2

Chapter 1 Preface

Table of Contents

1.1 Explanation of Symbols in This Manual 1-2
1.2 Revision History 1-2

1





Caution

- This manual provides an introduction to product functions, specifications, installation, basic operations and settings.
- This product is an OPEN TYPE device and therefore should be installed in an enclosure free of airborne dust, humidity, electric shock and vibration. Be sure there is sufficient airflow. The enclosure should prevent non-maintenance staff from operating the device (e.g. key or specific tools are required for operating the enclosure) in case that danger and damage on the device may occur.
- Be sure to read the manual carefully and follow the instructions so as to avoid injuries to personnel and damage to products.

1.1 Explanation of Symbols in This Manual

- **Precautions before operation**

Before operation, please read relevant safety instructions carefully so as to prevent an injury to personnel and damage to products.

 Danger	indicates the highly potential hazards. Severe personal injury or even death will result if you do not follow the instructions.
 Warning	indicates the potential hazards. Minor personal injury or even death may result if you do not follow the instructions.
 Caution	indicates much attention should be paid. A bad accident can occur if you do not follow the instructions.

1.2 Revision History

Version	Revision	Release Date
1 st	The first version was published.	April 10, 2020

Chapter 2 Overview

Table of Contents

2.1 Characteristics	2-2
2.2 Supported CANopen Services	2-2
2.3 Specifications	2-3
2.4 Extension Modules Connectable to RTU-CN01	2-4

1. Thank you for choosing Delta RTU-CN01. To ensure correct installation and operation of RTU- CN01, please read this manual carefully before using your RTU-CN01.
2. This manual only provides introductory information on RTU-CN01. For more detailed information on CANopen protocol, please refer to relevant references or literatures.
3. RTU-CN01 is defined as a CANopen slave and DVP-S series DI / DO modules and special modules can be connected on its right side.
4. Refer to **DVP-PLC Application Manual: Special Modules** for more details on how to use DVP-S series special modules.

2.1 Characteristics

- As a CANopen slave, RTU-CN01 supports such services as PDO, SDO, SYNC, NMT and Error Control.
- On its right side, RTU-CN01 can connect DVP-S series right-side modules with maximum 128 digital input points and 128 digital output points as well as maximum 8 special modules including analog modules, temperature modules, pulse modules and etc.
- Maximum 14 DVP-S series digital modules and special modules in total can be connected to the right side of RTU-CN01.
- The network configuration software provides the graphic configuration interface, automatically scans and recognizes extension modules, configures CR registers of special modules as IO data, sets the methods to deal with the errors and diagnoses the error status of each module.
- Users can select that the output values of right-side special modules and digital output point values of digital modules keep the same as they are before disconnection or change to zero when RTU-CN01 is disconnected from the master.

2.2 Supported CANopen Services

- Standard CANopen protocol, DS301v4.02.
- NMT service
- The Error Control protocol and Heartbeat protocol
- PDO service, maximum 8 TxPDO and 8 RxPDO configurable
- PDO transmission type: asynchronous, synchronous and cyclic, synchronous and acyclic
- SDO service

2.3 Specifications

■ CANopen communication port

Item	Specification
Transmission Method	CAN
Electrical Isolation	500 VDC
Interface	Removable connector (5.08 mm)
Transmission Cable	Two communication wires, one shield wire and one ground wire

■ CANopen communication

Item	Specification
Message type	PDO, SDO, SYNC, Emergency, NMT
Baud Rates	10 kbps, 20 kbps, 50 kbps, 125 kbps, 250 kbps, 500 kbps, 800kbps, 1M kbps

■ Electrical specification

Item	Specification
Power voltage	24 VDC (-15% ~ 20%)
Consumption power	2.5W
Insulation voltage	500V

■ Environment

Item	Specification
Noise Immunity	ESD (IEC 61131-2, IEC 61000-4-2): 8KV Air Discharge, 6KV Contact Discharge EFT (IEC 61131-2, IEC 61000-4-4): Power Line: 2KV, Digital I/O: 1KV Communication I/O: 2KV Damped-Oscillatory Wave: Power Line: 1KV, Digital I/O: 1KV RS (IEC 61131-2, IEC 61000-4-3): 80MHz~1000MHz , 10V/m; 2000 MHz ~6000 MHz,3V/m
Operation	0°C ~ 55°C (temperature), 50 ~ 95% (humidity), pollution degree 2
Storage	-25°C ~ 70°C (temperature), 5 ~ 95% (humidity)
Vibration/shock resistance	Standard: IEC 61131-2、IEC 68-2-6 (TEST Fc)/IEC 61131-2 & IEC 68-2-27 (TEST Ea)
Certificates	IEC 61131-2, UL508
Weight	71g

2.4 Extension Modules Connectable to RTU-CN01

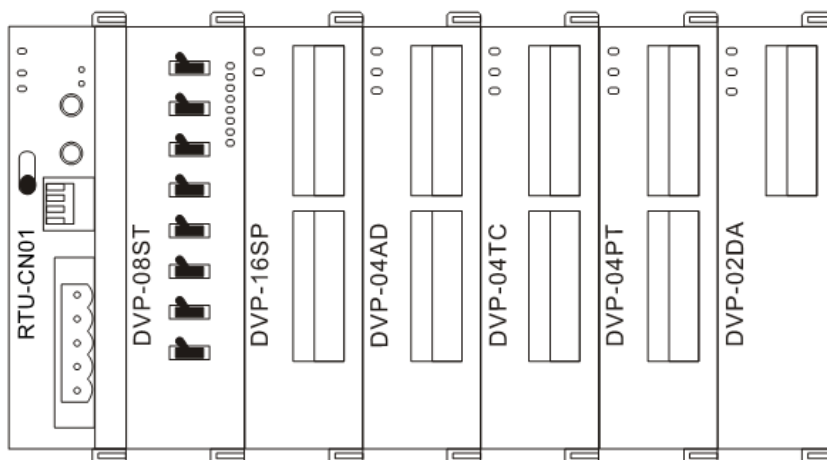

■ Digital modules connectable to RTU-CN01

DI/DO module (Model name)	Default I/O mapping data (CANopen→RTU-CN01)	Default I/O mapping data (RTU-CN01→CANopen)
DVP08SM11N	N/A	8 bits
DVP-08SM10N	N/A	8 bits
DVP16SM11N	N/A	16 bits
DVP06SN11R	8 bits	N/A
DVP08SN11R/T	8 bits	N/A
DVP08SN11TS	8 bits	N/A
DVP16SN11T	16 bits	N/A
DVP16SN11TS	16 bits	N/A
DVP08SP11R/T	8 bits	8 bits
DVP08SP11TS	8 bits	8 bits
DVP16SP11R/T	8 bits	8 bits
DVP16SP11TS	8 bits	8 bits
DVP32SM11N	N/A	32 bits
DVP32SN11TN	32 bits	N/A
DVP08ST11N	N/A	8 bits

■ Special modules connectable to RTU-CN01

Special module (Model name)	Default I/O mapping data (CANopen→RTU-CN01)		Default I/O mapping data (RTU-CN01→CANopen)	
	Start CR	Length (words)	Start CR	Length (words)
DVP02DA-S	CR10	2	N/A	N/A
DVP04DA-S	CR6	4	N/A	N/A
DVP04DA-S2	CR6	4	N/A	N/A
DVP04AD-S	N/A	N/A	CR12	4
DVP04AD-S2	N/A	N/A	CR12	4
DVP06AD-S	N/A	N/A	CR12	6
DVP04TC-S	N/A	N/A	CR14	4
DVP04PT-S	N/A	N/A	CR18	4
DVP06PT-S	N/A	N/A	CR18	6
DVP06XA-S	CR10	2	CR12	4
DVP06XA-S2	CR10	2	CR12	4
DVP01PU-S	CR42	4	CR33	4
DVP02TUL-S	CR4	2	CR2	2
DVP02TUR-S	CR4	2	CR2	2
DVP02TUN-S	CR4	2	CR2	2

Note:

- ✓ When special modules are connected to RTU-CN01, the start one of CRs for data upload and download and the length of the data to be uploaded and downloaded can be set up in the CANopen network configuration tool.

MEMO

2

Chapter 3 Profile and Parts

Table of Contents

3.1 Profile and Dimension	3-2
3.2 Parts	3-2
3.3 CANopen Port	3-3
3.4 RUN/STOP Switch.....	3-3
3.5 Address Switches.....	3-3
3.6 Function Switch	3-4
3.7 IO Extension Interface.....	3-4

3.1 Profile and Dimension

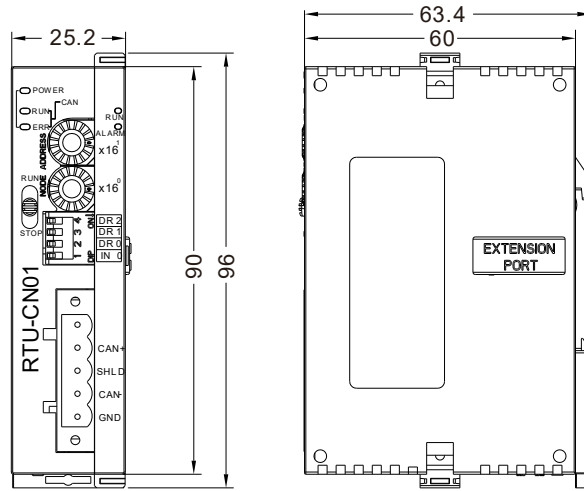

Unit: mm

3.2 Parts

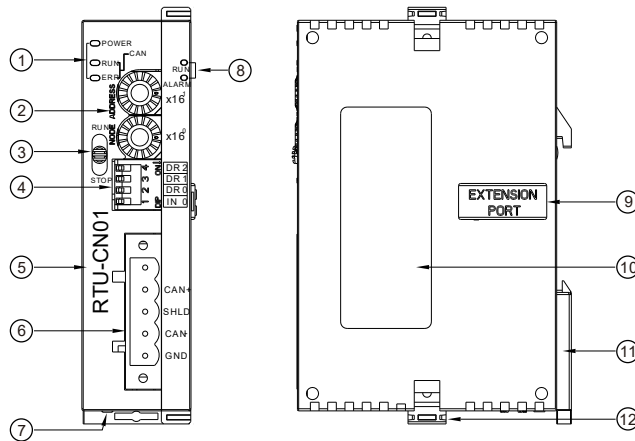

1. State indicators	7. 24VDC power port
2. Address switch	8. State indicators
3. RUN/STOP switch	9. Right-side extension module port
4. Function switch	10. Nameplate
5. Model name	11. DIN rail clip
6. CANopen port	12. Extension module fixing clip

3.3 CANopen Port

PIN	Signal	Description
1	GND	0 VDC
2	CAN_L	Signal-
3	SHLD	Shielded
4	CAN_H	Signal+
5	-	Reserved

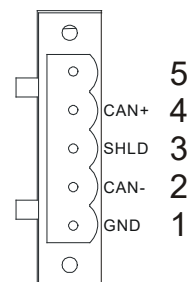

3.4 RUN/STOP Switch

RUN/STOP Switch	Description
STOP → RUN	<ol style="list-style-type: none"> To re-detect the extension module. To read/write the data in the extension module.
RUN → STOP	To stop reading/writing the data in the extension module.

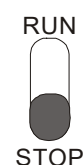

3.5 Address Switches

The switches are used for setting up the node address of RTU-CN01 on CANopen network. Range: 1~7F (0, 80~FF are forbidden).

Switch setting	Description
1~7F	Valid CANopen node address
0, 80~FF	Invalid CANopen node address

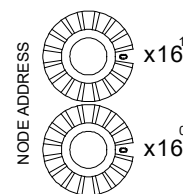

Example:

If you need to set the node address of RTU-CN01 to 26 (1AH), simply switch the corresponding switch of $x16^1$ to 1 and the corresponding switch of $x16^0$ to A.

Note:

- ✓ Please set up the node address when the power is switched off. After the setup is completed, re-power RTU-CN01.
- ✓ When RTU-CN01 is operating, changing the setting of the node address will be invalid.
- ✓ Use the slotted screwdriver to rotate the switch carefully in case the switch is scratched.

3.6 Function Switch

The function switch is used for setting the baud rate of CANopen network via DR0 ~ DR2 and data retention via IN0.

DR2	DR1	DR0	Baud Rate	Max. communication distance
OFF	OFF	OFF	10 Kbps	5000m
OFF	OFF	ON	20 Kbps	2500m
OFF	ON	OFF	50 Kbps	1000m
OFF	ON	ON	125 Kbps	500m
ON	OFF	OFF	250 Kbps	250m
ON	OFF	ON	500 Kbps	100m
ON	ON	OFF	800 Kbps	50m
ON	ON	ON	1 Mbps	25m
IN0		OFF	When RTU-CN01 is disconnected from the master, the output values of the special modules on its right side turn to 0 and all output points of its digital modules change to OFF.	
		ON	When RTU-CN01 is disconnected from the master, the output values of the special modules on its right side and all output point values of its digital modules keep the same as they are before disconnection.	

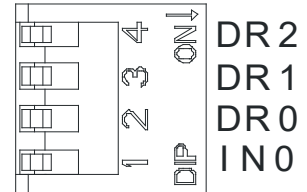

3

Note:

- ✓ Please set up the function switch when the power is switched off. After the setup is completed, re-power RTU-CN01.
- ✓ Use the slotted screwdriver to adjust the DIP switch carefully in case the switch is scratched.

3.7 IO Extension Interface

The interface is used for connecting Delta DVP-S series DI/DO extension modules and special modules.

Chapter 4 Installing and Wiring

Table of Contents

4.1 Installing RTU-CN01 and DVP-S Extension Modules.....	4-2
4.2 Installing RTU-CN01 and DVP-S Modules on DIN Rail	4-2
4.3 Connecting to CANopen Bus.....	4-3
4.3.1 Connecting to CANopen Port.....	4-3
4.3.2 CANopen Network Topology	4-3
4.3.3 Connecting to CANopen Port.....	4-3
4.4 Wiring	4-4
4.4.1 Power Input	4-4
4.4.2 Ground	4-5

4.1 Installing RTU-CN01 and DVP-S Extension Modules

- Pull open the fixing clips on the top and bottom of RTU-CN01, aim the extension module at the guiding holes and keep them met.
- Press the fixing clips on the top and bottom of RTU-CN01 to fix extension modules and ensure that the connection is fine.

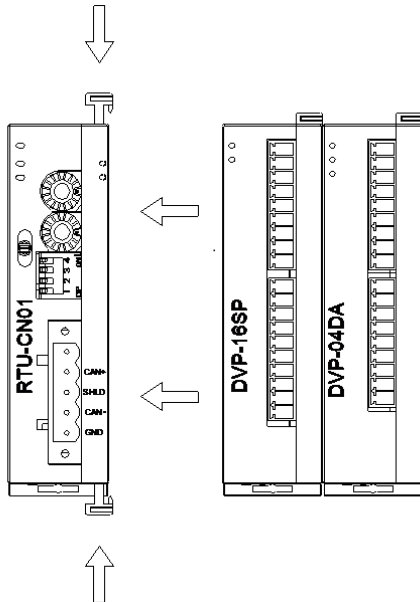

4.2 Installing RTU-CN01 and DVP-S Modules on DIN Rail

- Use the 35mm standard DIN rail.
- Pull open the DIN rail clips of RTU-CN01 and extension modules. Insert RTU-CN01 and extension modules into the DIN rail.
- Press the DIN rail clips of RTU-CN01 and extension modules to fix them on the DIN rail, as shown below.

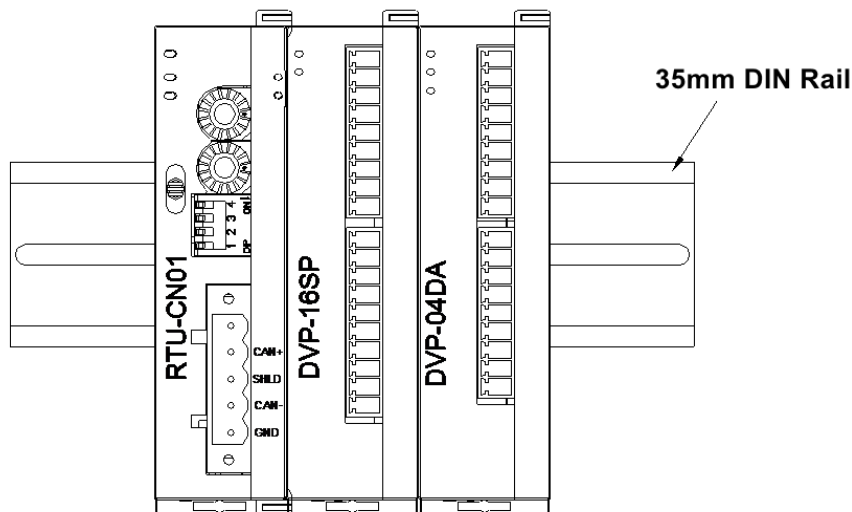

4.3 Connecting to CANopen Bus

4.3.1 Connecting to CANopen Port

- Please wire CANopen connector according to its pin definitions
- Plug the communication terminals into the CANopen connection port of RTU-CN01.

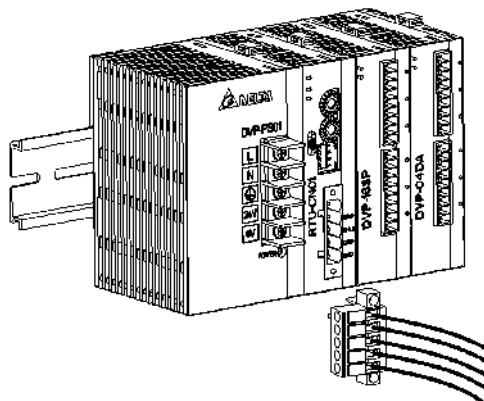

4.3.2 CANopen Network Topology

Both of the two ends of a CANopen network need be connected with the terminal resistors of 120Ω to enhance the stability of CANopen communication. See the illustration of a basic CANopen network topology below.

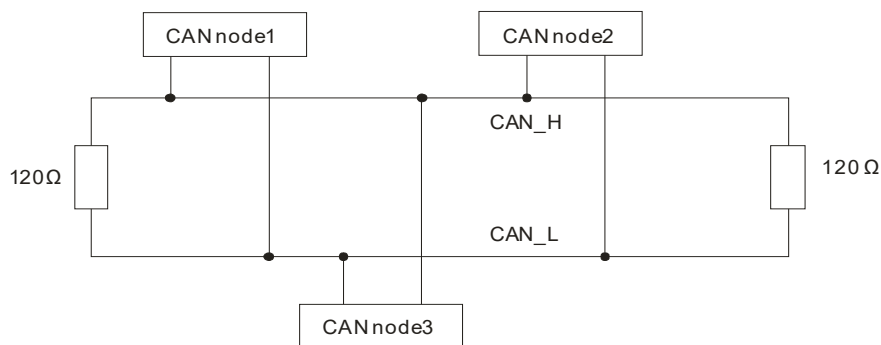

4.3.3 Connecting to CANopen Port

- Delta standard cables, UC-DN01Z-01A thick cable, UC-DN01Z-02A thin cable and UC-CMC010-01A thin cable are recommended for building a CANopen network. Please keep the communication cable away from the power cable. For specifications of cables, see List of Accessories in Appendix A.
- The terminal resistor of 120Ω should be connected between CAN_H and CAN_L of two respective ends of the network. Users can purchase Delta terminal resistor, TAP-TR01.

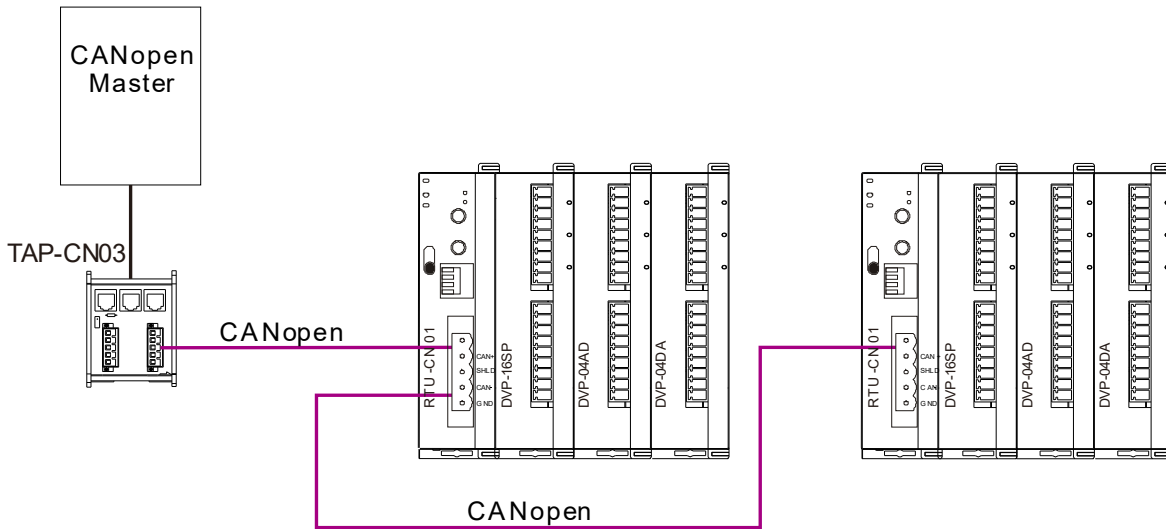

4

4.4 Wiring

4.4.1 Power Input

The power input of RTU-CN01 is 24VDC. Please notice the following points during use.

⚠ Warning

- Connect the supply power to the two terminals, 24V and 0V and the grounding terminal to the earth. Be cautious that the RTU-ECAT device may be damaged if the positive and negative polarities of the supply power are connected reversely.
- Please be sure to use certified power supply with SELV output or certified power supply providing double insulation evaluated by UL60950, or UL61010-1 and UL61010-2-201 standards
- Use copper conductors as power wires only. The diameter of the power wire must be between 12 and 28AWG and the rated temperature should be greater than 70°C. The power terminal block plug wiring torque is 4.5 in-lbs.
- The cables for the 110V and 220V AC power supply and the 24V DC power supply must be twisted and connected to the module as short as possible in length.
- Do not combine the AC 110V, 220V, and DC 24V cables with the main circuit and I/O signal cables together and please keep them away from each other. If the space permits, it's recommended to separate these lines by more than 100mm.

RTU-CN01 Safety Circuit Wiring

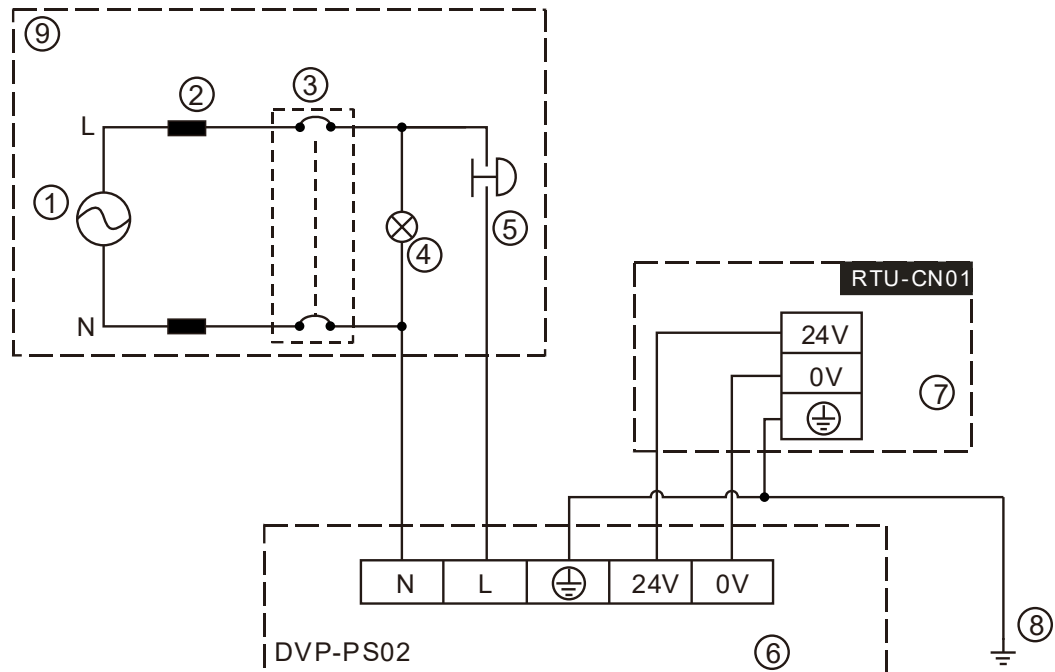

①	AC power supply: 100 ~ 240VAC, 50/60Hz.
②	Power supply circuit protection fuse
③	System circuit isolation device: The electromagnetic contactor, relay and other switch can be used as the isolation device to prevent the system from becoming unstable when the power supply is discontinuous.
④	Power supply indicator
⑤	Emergency stop button: The button cuts off the system power supply when an accidental situation takes place.
⑥	Delta power module DVP-PS02/24VDC
⑦	RTU-CN01 device
⑧	Ground
⑨	Safety circuit

4.4.2 Ground

- The diameter of the ground should not be less than the diameters of the cables connected to the terminals L and N.
- If using multiple pieces of equipment, use a single-point ground.

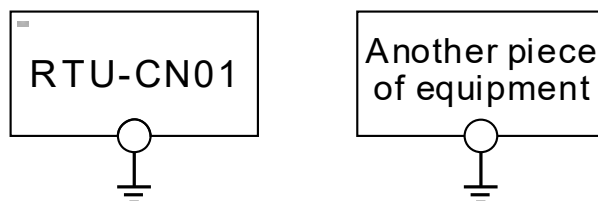

The single-point ground is better.

- If you cannot use a single-point ground, use a common-point ground.

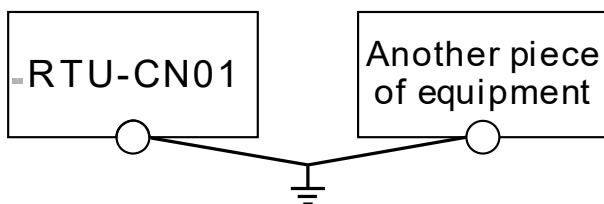

The common-point ground is permitted.

- Do not connect equipment ground wires together as shown below.

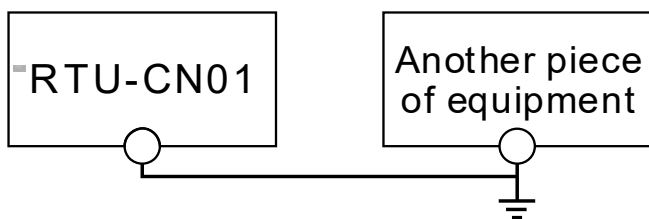

The equipment can not be grounded in this way.

4

Chapter 5 Configuring RTU-CN01

Table of Contents

5.1 Terms	5-2
5.2 Introduction to the Software Interfaces	5-3
5.2.1 RTU Setting tab	5-6
5.2.2 "RTU Setup" Interface	5-6
5.2.3 Control Word and Status Word in RTU-CN01.....	5-8
5.2.4 "Special Module Configuration" Interface.....	5-10
5.2.5 The Interface for Configuring Digital Modules.....	5-13
5.2.6 "RTU IO Mapping" Interface	5-15
5.3 CANopen IO Mapping	5-15
5.3.1 IO Data Mapping.....	5-15
5.3.2 PDO Mapping.....	5-18
5.3.3 Adding RTU-CN01 Configuration to Node Configuration List	5-20

1. As a CANopen slave, RTU-CN01 works to achieve the data exchange between CANopen master and DVP-S series extension modules.
2. RTU-CN01 sends the data that the CANopen master outputs to extension modules.
3. RTU-CN01 sends the data that extension modules input to the CANopen master.

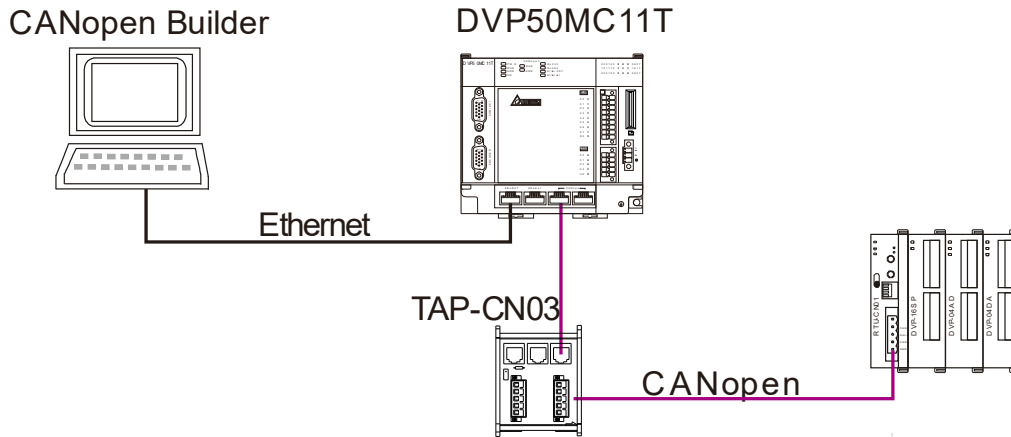

5.1 Terms

■ The terms used in the configuration of RTU-CN01 are explained in the following table.

No.	Name	Unit	Explanation
1	Control word	Word	Controls the state of RTU-CN01 into RUN or STOP. When the content of the control word is 16#8000, RTU-CN01 is in STOP state. When the content of the control word is 16#8001, RTU-CN01 is in RUN state. See section 5.2.3 for more details.
2	Status word	Word	Displays the status of RTU-CN01. See section 5.2.3 for more details.
3	DI Module Points	Bit	The number of digital input points of digital modules connected on the right side of RTU-CN01. The number of digital input points is a multiple of 8. The number is regarded as 8 when it is less than 8 and as 16 when it is greater than 8 but less than 16.
4	DO Module Points	Bit	The number of digital output points of digital modules connected on the right side of RTU-CN01. The number of digital output points is a multiple of 8. The number is regarded as 8 when it is less than 8 and as 16 when it is greater than 8 but less than 16.
5	Input IO data length	Byte	The length of data that RTU-CN01 transmits to the master, which is configured in PDO.
6	Output IO data length	Byte	The length of data that the master transmits to RTU-CN01, which is configured in PDO.
7	Special Module Number	Unit	Number of special modules connected to RTU-CN01. Range: 0~8
8	Diagnostic Interval Time	Sec	The interval when RTU-CN01 executes the diagnosis of the special modules on its right side. Range: 1 ~ 65, Default: 5 seconds

No.	Name	Unit	Explanation
9	Special Module Offline Treatment	N/A	How RTU-CN01 will react when one special module connected to it is offline. You can choose "Ignore" or "Alarm". Default: Alarm
10	Special Module Error Treatment	N/A	How RTU-CN01 will react when it detects errors. You can choose "Ignore" or "Alarm". Default: Alarm
11	Reset RTU	N/A	Restores the configuration of RTU-CN01 to default settings.
12	Clear Config	N/A	Clears the current configuration data of RTU-CN01.
13	Add control word and status word to I/O data	N/A	For you to decide whether or not to add control word and status word to I/O data. If you do not choose the item, the I/O data in RTU-CN01 and CANopen master will not include control word and status word. If you choose the item, the I/O data in RTU-CN01 and CANopen master will include control word and status word.
14	Work mode	N/A	For you to set up the work mode of the special module connected to RTU-CN01. When "Auto" is selected, RTU-CN01 will configure default CR of the special module as CANopen I/O mapping data. When "Custom" is selected, you can configure any CR in the special module as CANopen I/O mapping data.
15	Input Link Number	Link	Number of input data links of the special module connected to RTU-CN01. It is valid under Custom mode. The start CR and the number of CRs (Number) are specified in one input link e.g. Link1, Link2...
16	Output Link Number	Link	Number of output data links of the special module connected to RTU-CN01. It is valid under Custom mode. The start CR and the number of CRs (Number) are specified in one output link e.g. Link1, Link2...
17	Input Data Length	Word	The sum of the length of the link input data of the special modules currently connected to RTU-CN01.
18	Output Data Length	Word	The sum of the length of the link output data of the special modules currently connected to RTU-CN01.
19	IO mapping	Word	The I/O mapping relation between RTU-CN01 and the special module/digital module connected to it.

5.2 Introduction to the Software Interfaces

This section takes the CANopen Builder software as an example to describe how to configure RTU-CN01.

First add the RTU-CN01 slave to the CANopen configuration interface of the CANopen software.

1. Start the CANopen Builder software and then the software interface is shown as follows.

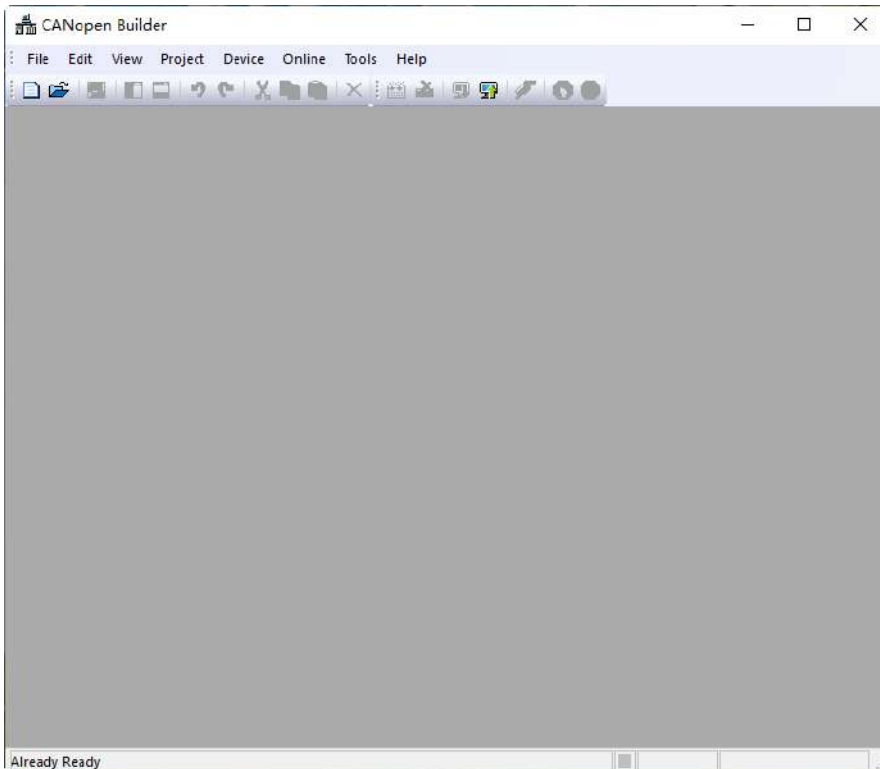

2. Click on **"New Project"**, select DVP50MC11T in the **"Model Selection"** field. After setting is done, click the **"OK"** button to return to the main interface.

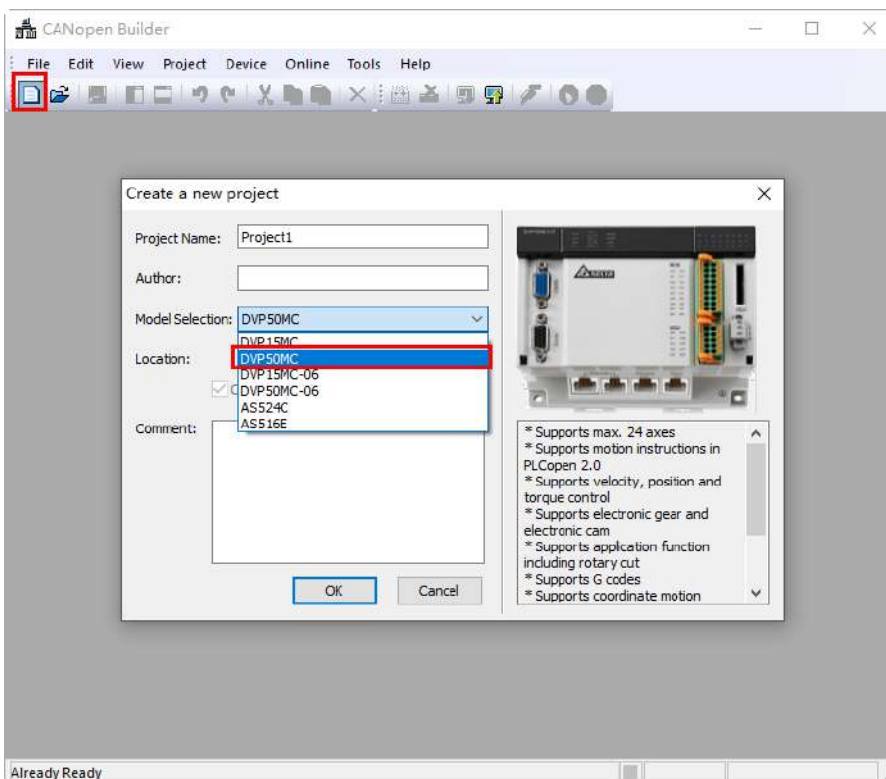

3. Click on the "+" to the left of **"Network Configuration"** item, and then double-click on **"CANopen"** to make the CANopen configuration interface appear as shown below.

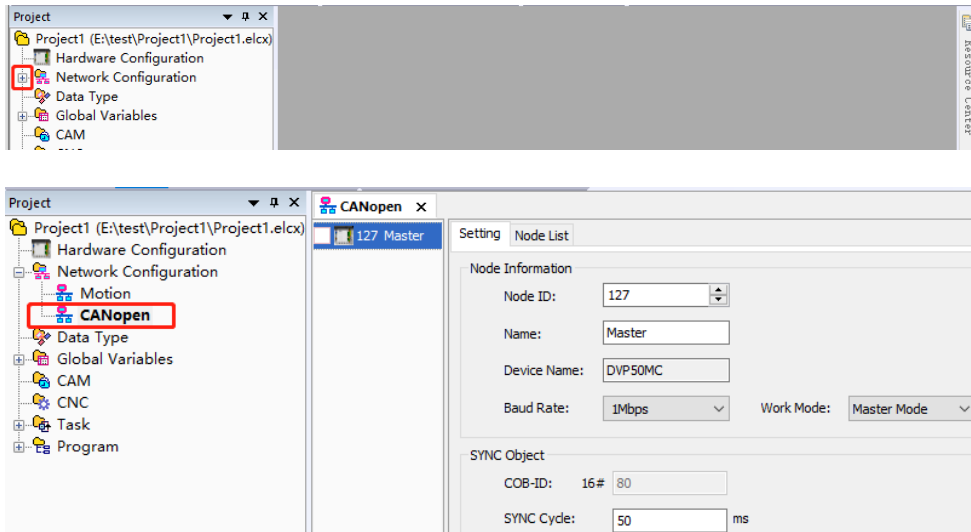

- Right-click on **"127Master"** in the CANopen configuration interface, and then click on **"Add Device"**. You can also click on **"Scan Network"** to scan the connected slave device

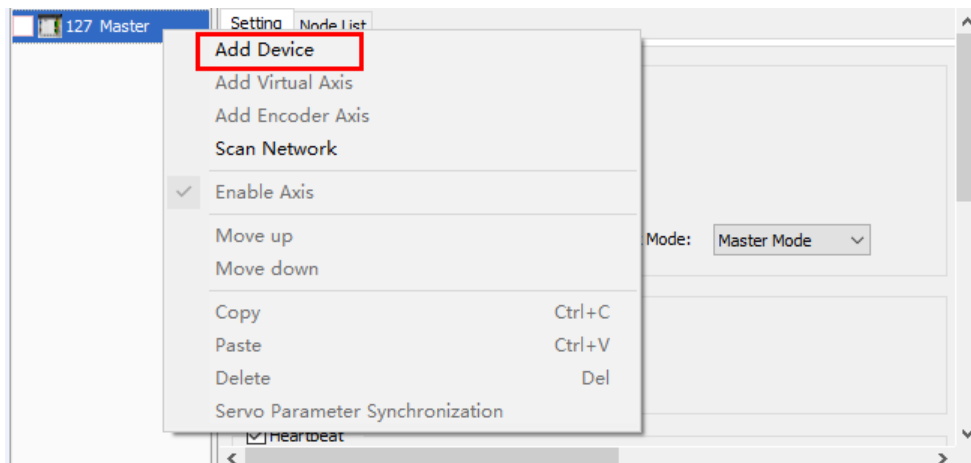

- After clicking on **"Add Device"** option, a dialog box appears. Select RTU-CN01 in the dialog box and click **"Add"** button. Afterward, click **"Cancel"** to close the dialog box.

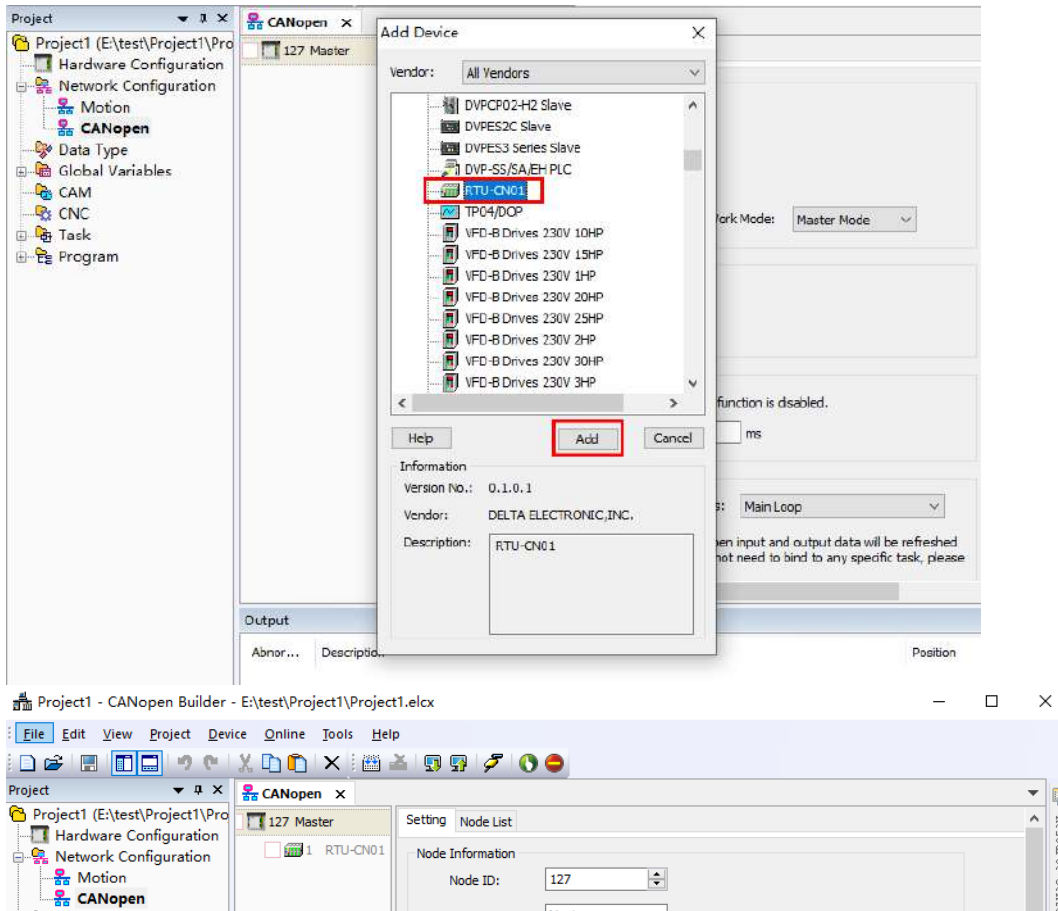

5

5.2.1 RTU Setting tab

After the RTU-CN01 slave is added in the software, click on the RTU-CN01 on the left side, click on RTU Setting and then the main interface for configuring RTU is shown as below.

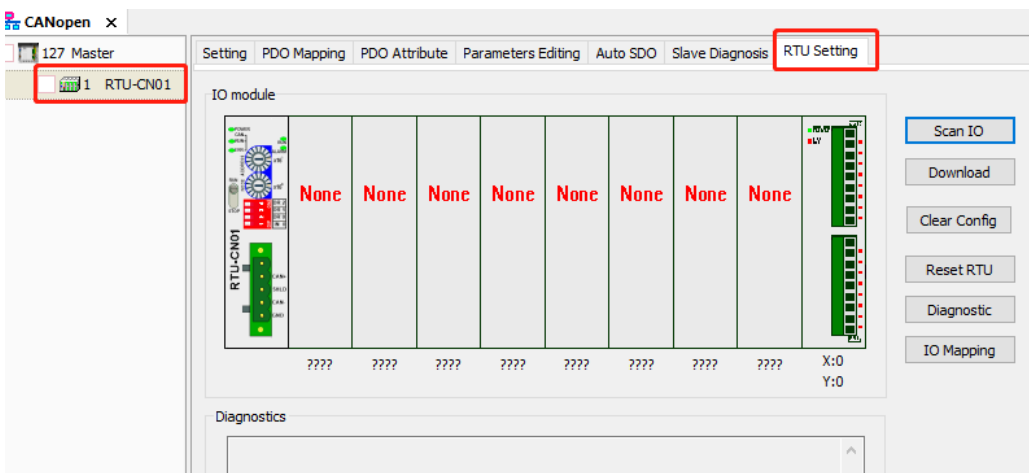

5.2.2 "RTU Setup" Interface

The "RTU Setup" window will pop up by double-clicking on the RTU-CN01 symbol on the left of the "RTU Setting" interface. It mainly displays the number of DVP-S series special modules connected

on the right side of RTU-CN01, the number of inputs and output points of digital modules, the error control treatment of RTU-CN01 and whether to add the control word and status word to IO data as shown in the figure below.

Explanation of RTU setup parameters:

Item	Content	Default
Input Data Length	The total length of the status word of RTU-CN01 and the input data of the extension modules. Unit: Byte. The status word occupies 2 bytes. Each input channel of a special module occupies 2 bytes. 8 points for digital input are counted as 1 byte.	0
Output Data Length	The total length of the control word of RTU-CN01 and the output data of its extension modules. Unit: Byte. The control word occupies 2 bytes. Each output channel of a special module occupies 2 bytes. 8 points for digital output are counted as 1 byte.	0
DI Module Points (X)	The number of digital input points of the digital modules connected on the right side of RTU-CN01. The number of digital input points should be a multiple of 8. The number will be regarded as 8 when it is less than 8 and as 16 when it is greater than 8 but less than 16.	0
DO Module Points (Y)	The number of digital output points of the digital modules connected on the right side of RTU-CN01. The number of digital output points should be a multiple of 8. The number will be regarded as 8 when it is less than 8 and as 16 when it is greater than 8 but less than 16.	0
Special Module Number	The number of special modules connected to RTU-CN01. Range: 0 ~ 8	0
Diagnostic Interval Time	The interval time for RTU-CN01 to execute the diagnosis of special modules. Range: 1~65 seconds.	5 secs

Item	Content	Default
Special Module Offline Treatment	How RTU-CN01 will react when the special module connected to it is offline. You can choose "Ignore" or "Alarm".	Alarm
Special Module Error Treatment	How RTU-CN01 will react when it detects an error in a special module connected on its right side. You can choose "Ignore" or "Alarm".	Alarm
Add control word and status word to IO data	For you to decide whether or not to add the control word and status word to I/O data. If you do not choose the item, the PDO configuration data for RTU-CN01 will not include the control word and status word. If you choose the item, the PDO configuration data for RTU-CN01 will include the control word and status word.	Not add control word and status word to I/O data

5.2.3 Control Word and Status Word in RTU-CN01

Control word

Bit	Value	Explanation
Bit 0	0	RTU-CN01 is set to STOP as bit 15 of the control word parameter is 1 and bit 0 is 0.
	1	RTU-CN01 is set to RUN as bit 15 of the control word parameter is 1 and bit 0 is 1.
Bit 1	0/1	Reserved
Bit 2	0/1	Reserved
Bit 3	0/1	Reserved
Bit 4	0/1	Reserved
Bit 5	0/1	Reserved
Bit 6	0/1	Reserved
Bit 7	0/1	Reserved
Bit 8	0/1	Reserved
Bit 9	0/1	Reserved
Bit 10	0/1	Reserved
Bit 11	0/1	Reserved
Bit 12	0/1	Reserved
Bit 13	0/1	Reserved
Bit 14	0/1	Reserved

Bit	Value	Explanation
Bit 15	0	Control word is disabled. When the bit value is 0, RTU-CN01 can not be controlled to be in RUN or STOP state via bit0.
	1	Control word is enabled. When the bit value is 1, RTU-CN01 can be controlled to be in RUN or STOP state via bit0.

Status Word

Bit	Status value	Explanation
Bit 0	0	RTU-CN01 detects some extension module.
	1	No extension module is detected by RTU-CN01.
Bit 1	0	The extension modules connected to RTU-CN01 are consistent with the configuration.
	1	The extension modules connected to RTU-CN01 are inconsistent with the configuration.
Bit 2	0	No error occurs in special modules.
	1	An error occurs in special modules.
Bit 3	0	Special modules operate normally.
	1	It is detected that one special module fails to communicate with RTU-CN01.
Bit 4	0	The configuration data is valid.
	1	The configuration data is invalid.
Bit 5	0	The power voltage of RTU-CN01 is normal.
	1	The power of RTU-CN01 is in low voltage.
Bit 6	0	RTU-CN01 can identify connected modules.
	1	RTU-CN01 detects some special modules which are unable to be identified.
Bit 7	0	RTU-CN01 working normally.
	1	There are more than 8 special modules connected to RTU-CN01, or the number of digital input or output points exceeds 128.
Bit 8	0	Reserved
	1	Reserved
Bit 9	0	RTU-CN01 is in RUN state
	1	RTU-CN01 is in STOP state.
Bit 10	0/1	Reserved

Bit	Status value	Explanation
Bit 11	0/1	Reserved
Bit 12	0/1	Reserved
Bit 13	0/1	Reserved
Bit 14	0/1	Reserved
Bit 15	0/1	Reserved

5.2.4 "Special Module Configuration" Interface

Double-click a special module symbol on the RTU Setting interface. For instance, with a double-click on 04AD symbol, the "Special Module Configuration" window will pop up for configuring a special module.

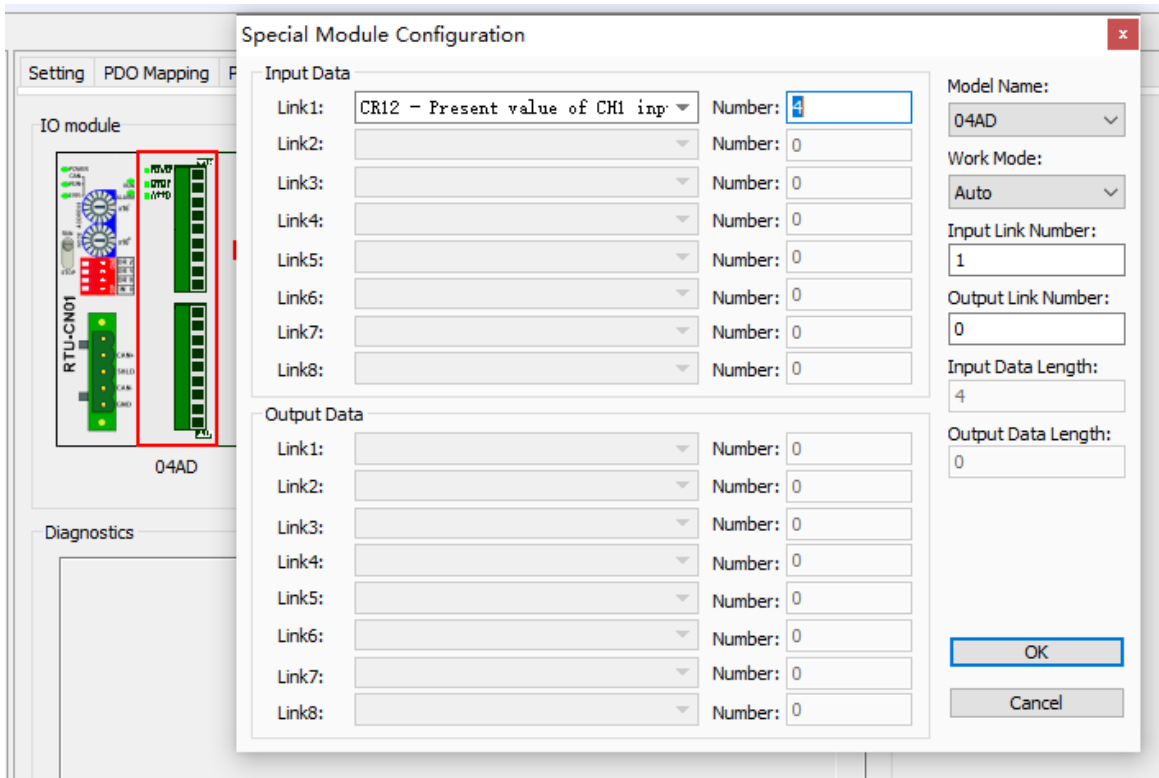

Explanation of “Special Module Configuration” interface:

Item		Description
Module Name		<p>One special module connected on the right side of RTU-CN01, such as 02DA, 04AD, 04DA, 04TC, 06AD and 06XA. Choose one from them based on actually connected special modules. Refer to Extension Modules Connectable to RTU-CN01 in Section 1.4 for details.</p> <p>The special module positions configured in the software correspond to the positions of the special modules actually connected. The positions of digital modules are not counted.</p> <p>For example, the actually connected modules on the right side of RTU-CN01 are DVP04AD-S, DVP16SP11T and DVP04DA-S. So select 04AD for the first position on the right side of RTU-CN01 and 04DA for the second one. Enter 8 for digital input points (X) and 8 for digital output points (Y) on the rightmost side in the software window.</p>
Work Mode		<p>Auto mode and Custom mode are provided for option.</p> <p>If “Auto” is selected, CRs (internal registers in a special module) which are often used are assigned automatically by the software, e.g. the present value of the input signal of one AD module. The CR which is assigned by the software can not be replaced.</p> <p>If “Custom” is selected, choose CRs for the special module which need be configured in the software according to actual demand.</p>
Input Link Number		The number of input data links to be open is decided by the value here. If the value is 1, Link 1 for input data will be open in the software.
Output Link Number		The number of output data links to be open is decided by the value here. If the value is 2, Link 1 and Link 2 for output data will be both open.
Input Data Length		The sum of link input data lengths of the current special module
Output Data Length		The sum of link output data lengths of the current special module
Input Data	Link1	The start CR of input data link 1
	Number	<p>The length of data which starts with input data link 1 (Unit: Word)</p> <p>If input data link 1 is specified as CR12 and Number specified for link 1 is 4, then CR12~ CR15 are configured into the input data.</p>
Output Data	Link1	The start CR of output data link 1
	Number	<p>The length of data which starts with output data link 1 (Unit: Word)</p> <p>If output data link 1 is specified as CR6, Number specified for link 1 is 4, then CR6~ CR9 are configured into the output data.</p>

- Setting the input mode for a special module in the custom work mode

With a double-click on “04AD” symbol, the following special module configuration window appears right away. Select “Custom” in the Work Mode field. For Link1 of output data, choose “CR1 -Input mode setting” with the number set to 1. Then click “OK” to finish the setting.

Note:

1. CR1 in DVP04AD-S sets the work modes of four channels of the module. (Four modes per channel)
2. Based on the actual need, users use twelve bits of CR1 in the special module (bit 0 ~ bit 11) to set the work mode for each channel individually.
3. For instance, to set the input mode to mode 0 (bit 2 ~ bit 0=000) for channel 1, to mode 1 (bit 5 ~ bit 3=001) for channel 2, to mode 2 (bit 8 ~ bit 6=010) for channel 3 and to mode 3 (bit 11 ~ bit 9=011) for channel 4, the corresponding PDO value of CR1 should be set to 16#688.
4. The factory setting value of CR1 in DVP04AD-S is 0.
5. Refer to **DVP-PLC Application Manual: Special Modules** for more on DVP04AD-S.

- Using Auto SDO to set the input modes for a special module

Click “Add SDO” button on the “Auto SDO” tab page. Choose the index 16#2000 since DVP04AD-S is the first module on the right of RTU-CN01. Choose the subindex 16#2 since CR1 is the parameter for input mode setting.

To set the input mode to mode 3 for channel 1 and the input modes to mode 0 for channel 2~ channel 4, fill 16#3 in the “Data” field. Click “Add” to finish the setting.

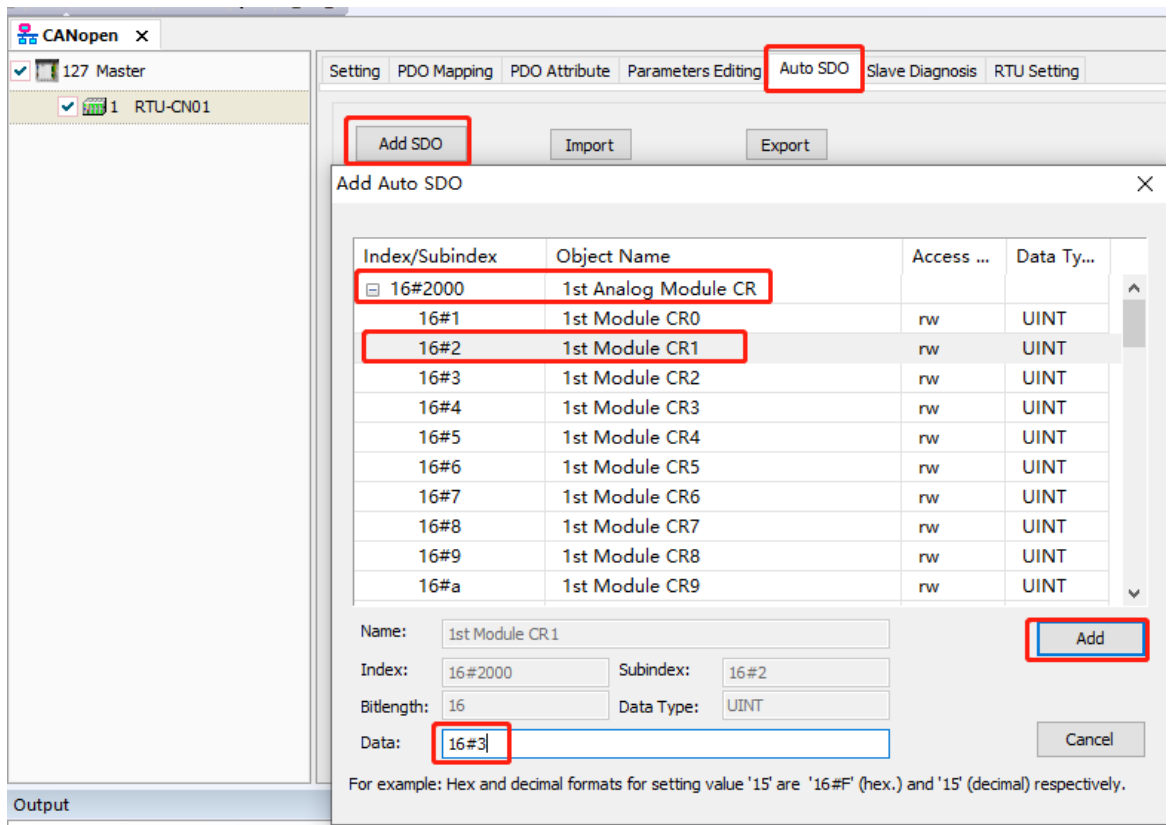

5.2.5 The Interface for Configuring Digital Modules

With a double-click on the symbol in the red box below, the digital input/output points interface will appear on the RTU configuration main interface. This interface is used to configure the number of input points and the number of output points of digital modules.

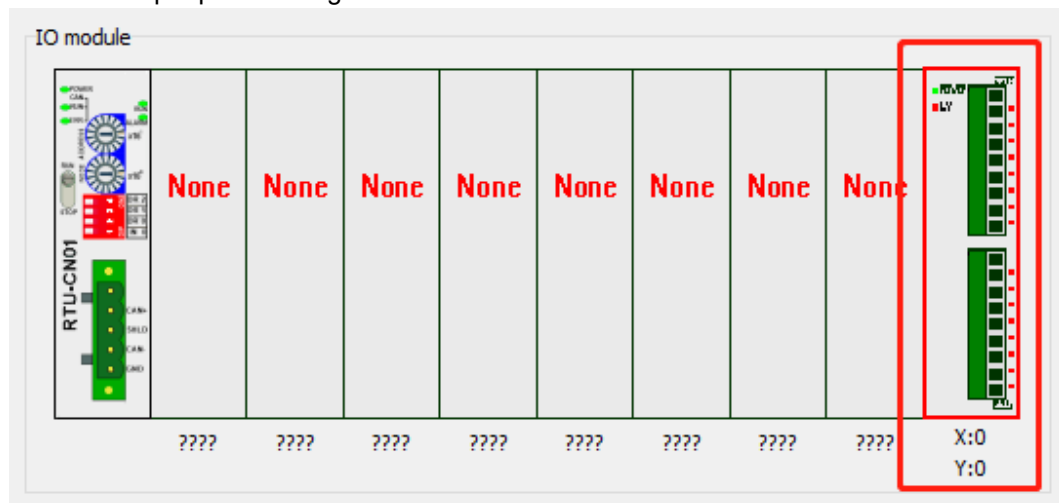

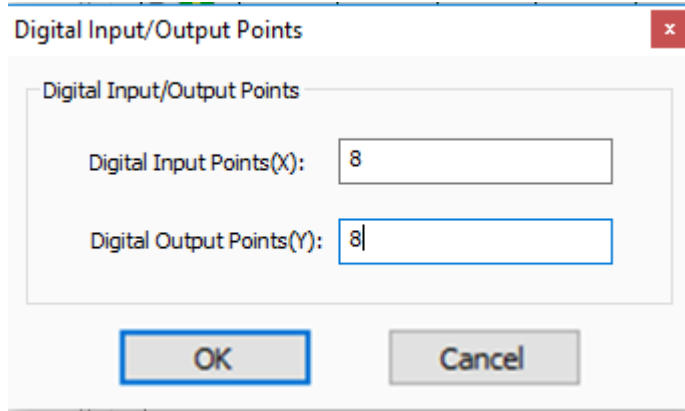

Explanation of parameters on the “Digital Input/Output Points” interface:

Item	Description
Digital Input Points (X)	<p>The number of all digital module input points. You can click the “Scan IO” button to get the number of all input points connected on the right side of RTU-CN01.</p> <p>You can also enter the number of input points on the right of RTU-CN01. The digital input point number should be a multiple of 8. It is counted as 8 if the number is less than 8 and counted as 16 if the number is greater than 8 but less than 16.</p>
Digital Output Points (Y)	<p>The number of all digital module output points. You can click the “Scan IO” button to get the number of all output points connected on the right of RTU-CN01.</p> <p>You can also enter the number of output points on the right side of RTU-CN01. The digital output point number should be a multiple of 8. It is counted as 8 if the number is less than 8 and counted as 16 if the number is greater than 8 but less than 16.</p>

5.2.6 “RTU IO Mapping” Interface

Clicking on “IO Mapping” button on the main interface, the “RTU IO Mapping” interface appears right away, where the inputs and outputs of digital modules and special modules are listed. See details in section 5.3.

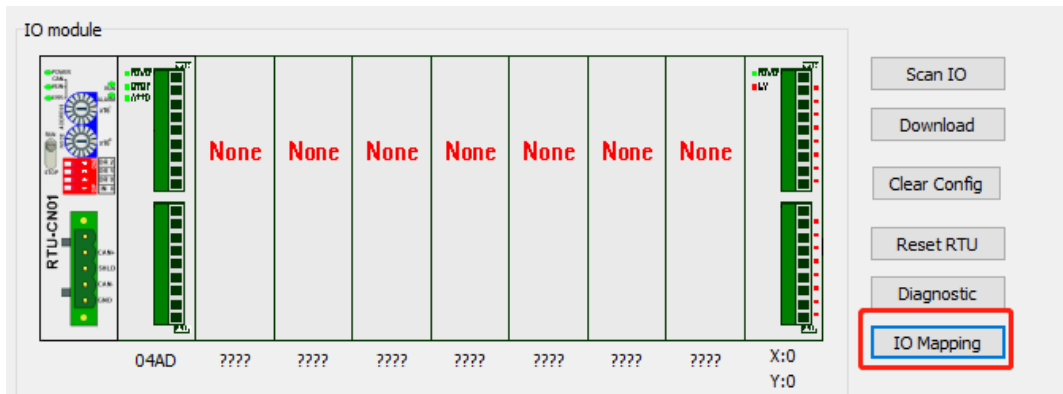

RTU IO Mapping

Input IO Data Mapping:				Output IO Data Mapping:			
No.	Description	Word	Byte	No.	Description	Word	Byte
1-[04AD]	CR12 - Present value of CH1 input...	0	0	DO(Y)	Y0-Y7	0	0
	CR13 - Present value of CH2 input...	1	2				
	CR14 - Present value of CH3 input...	2	4				
	CR15 - Present value of CH4 input...	3	6				
DI(X)	X0-X7	4	8				

Explanation of parameters in the **RTU IO Mapping** interface:

Item	Description
Input IO Data Mapping:	The data that RTU-CN01 transmits to the master
Output IO Data Mapping:	The data that the master transmits to RTU-CN01
No.	Module name and the position of the special module on the right side of RTU-CN01, including the special module name and its position number, the status word and control word as well as digital module input type and output type.
Description	The name of a mapping parameter
Word	Data length of a mapping parameter, unit: word
Byte	Data length of a mapping parameter, unit: byte

5.3 CANopen IO Mapping

5.3.1 IO Data Mapping

- If the control word and status word of RTU-CN01 are excluded in IO data, only special modules and digital modules are configured. E.g. in the following figure only four channels of outputs for DVP04DA-S and four channels of inputs for DVP04AD-S and 8 digital inputs and 8 digital outputs are configured.

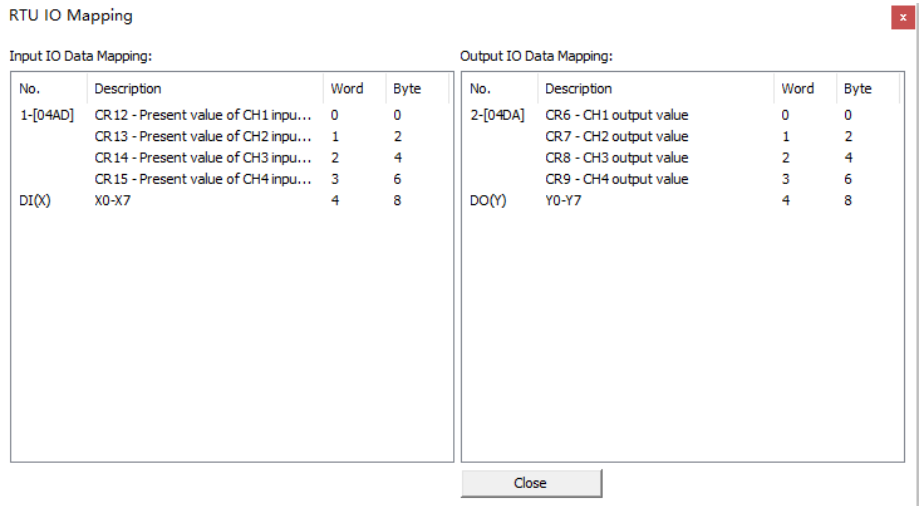

See the following tables for the explanation of IO mapping above.

● CANopen Master → RTU-CN01

Master (Byte)	RTU-CN01	
Byte0	Special module	Low byte of the channel 1 output value of the 1 st special module
Byte1		High byte of the channel 1 output value of the 1 st special module
Byte2		Low byte of the channel 2 output value of the 1 st special module
Byte3		High byte of the channel 2 output value of the 1 st special module
.....	
ByteN	DI/DO module	Y0 ~ Y7 of the 2 nd DI/DO module
ByteN+1		Y0 ~ Y7 of the 1 st DI/DO module
ByteN+2		Y0 ~ Y7 of the 4 th DI/DO module
ByteN+3		Y0 ~ Y7 of the 3 rd DI/DO module
.....	

● CANopen Master ← RTU-CN01

Master (Byte)	RTU-CN01	
Byte0	Special module	Low byte of the channel 1 input value of the 1 st special module
Byte1		High byte of the channel 1 input value of the 1 st special module

Master (Byte)	RTU-CN01	
Byte2		Low byte of the channel 2 input value of the 1 st special module
Byte3		High byte of the channel 2 input value of the 1 st special module
.....	
ByteN	DI/DO module	X0 ~ X7 of the 2 nd DI/DO module
ByteN+1		X0 ~ X7 of the 1 st DI/DO module
ByteN+2		X0 ~ X7 of the 4 th DI/DO module
ByteN+3		X0 ~ X7 of the 3 rd DI/DO module
.....	

- When the control word and status word of RTU-CN01 are included in IO data, in the following figure four channels of outputs for DVP04DA-S and four channels of inputs for DVP04AD-S and 8 digital inputs and 8 digital outputs as well as of Control Word and Status Word are configured.

Input IO Data Mapping:				Output IO Data Mapping:			
No.	Description	Word	Byte	No.	Description	Word	Byte
RTU	Status Word	0	0	RTU	Control Word	0	0
1-[04AD]	CR 12 - Present value of CH1 inpu...	1	2	2-[04DA]	CR6 - CH1 output value	1	2
	CR 13 - Present value of CH2 inpu...	2	4		CR7 - CH2 output value	2	4
	CR 14 - Present value of CH3 inpu...	3	6		CR8 - CH3 output value	3	6
	CR 15 - Present value of CH4 inpu...	4	8		CR9 - CH4 output value	4	8
DI(X)	X0-X7	5	10	DO(Y)	Y0-Y7	5	10

- See the following tables for the explanation of IO mappings above.

- CANopen master → RTU-CN01

Master (Byte)	RTU-CN01	
Byte0	RTU-CN01	Low byte of Control Word of RTU-CN01
Byte1		High byte of Control Word of RTU-CN01
Byte2	Special module	Low byte of the channel 1 output value of the 1 st special module
Byte3		High byte of the channel 1 output value of the 1 st special module
Byte4		Low byte of the channel 2 output value of the 1 st special module
Byte5		High byte of the channel 2 output value of the 1 st special module
.....	
ByteN	DI/DO module	Y0 ~ Y7 of the 2 nd DI/DO module
ByteN+1		Y0 ~ Y7 of the 1 st DI/DO module

Master (Byte)	RTU-CN01	
ByteN+2		Y0 ~ Y7 of the 4 th DI/DO module
ByteN+3		Y0 ~ Y7 of the 3 rd DI/DO module
.....	

● CANopen master ←RTU-CN01

Master (Byte)	RTU-CN01	
Byte0	RTU-CN01	Low byte of Status Word of RTU-CN01
Byte1		High byte of Status Word of RTU-CN01
Byte2	Special module	Low byte of the channel 1 input value of the 1 st special module
Byte3		High byte of the channel 1 input value of the 1 st special module
Byte4		Low byte of the channel 2 input value of the 1 st special module
Byte5		High byte of the channel 2 input value of the 1 st special module
.....	
ByteN	DI/DO module	X0~X7 of the 2 nd DI/DO module
ByteN+1		X0~X7 of the 1 st DI/DO module
ByteN+2		X0~X7 of the 4 th DI/DO module
ByteN+3		X0~X7 of the 3 rd DI/DO module
.....	

Note:

- ✓ If you choose “**Add control word and status word to I/O data**”, the first words in the input and output data areas will automatically be assigned to Status Word and Control Word respectively.
- ✓ For the extension modules connected to RTU-CN01, no matter how special modules and digital modules are placed, the special modules are assigned data ahead of DI/DO modules

5.3.2 PDO Mapping

- View the configured PDO mappings.

Click on “**PDO Mapping**” tab and then view the RTU parameters which have been configured as below.

Select a Receive PDO (RPDO)					Select a Transmit PDO (TPDO)				
Name	Index	Subindex	Bit len...		Name	Index	Subindex	Bit len...	
<input checked="" type="checkbox"/> receive_pdo_para1	16#1400				<input checked="" type="checkbox"/> transmit_pdo_para1	16#1800			
control word	16#3002	16#1	16		status word	16#3001	16#1	16	
CR6 - CH1 output value	16#2020	16#7	16		CR12 - Present value of CH1	16#2000	16#d	16	
CR7 - CH2 output value	16#2020	16#8	16		CR13 - Present value of CH2	16#2000	16#e	16	
CR8 - CH3 output value	16#2020	16#9	16		CR14 - Present value of CH3	16#2000	16#f	16	
<input checked="" type="checkbox"/> receive_pdo_para2	16#1401				<input checked="" type="checkbox"/> transmit_pdo_para2	16#1801			
CR9 - CH4 output value	16#2020	16#a	16		CR15 - Present value of CH4	16#2000	16#10	16	
Digital8_out 1	16#6200	16#1	8		Digital8_in 1	16#6000	16#1	8	
<input type="checkbox"/> receive_pdo_para3	16#1402				<input type="checkbox"/> transmit_pdo_para3	16#1802			
<input type="checkbox"/> receive_pdo_para4	16#1403				<input type="checkbox"/> transmit_pdo_para4	16#1803			
<input type="checkbox"/> receive_pdo_para5	16#1404				<input type="checkbox"/> transmit_pdo_para5	16#1804			
<input type="checkbox"/> receive_pdo_para6	16#1405				<input type="checkbox"/> transmit_pdo_para6	16#1805			
<input type="checkbox"/> receive_pdo_para7	16#1406				<input type="checkbox"/> transmit_pdo_para7	16#1806			
<input type="checkbox"/> receive_pdo_para8	16#1407				<input type="checkbox"/> transmit_pdo_para8	16#1807			

Note:

The PDO mappings which have already been configured can only be viewed in the above window instead of being modified.

- PDO Attribute

Click on “PDO Attribute” tab on the RTU configuration interface. The following interface is presented then.

Property of Receive PDO (RPDO)		Property of Transmit PDO (TPDO)							
Name	COB-ID	Transm...	Event	Inhibit	Name	COB-ID	Transm...	Event	Inhibit
receive_pdo_para1	16#201	255	--	--	transmit_pdo_para1	16#181	255	0	0
receive_pdo_para2	16#301	255	--	--	transmit_pdo_para2	16#281	255	0	0

With a double-click on the selected PDO, the “Editing PDO” interface appears, where you select one transmission type. See section 5.2 for the introduction of PDO **transmission** type.

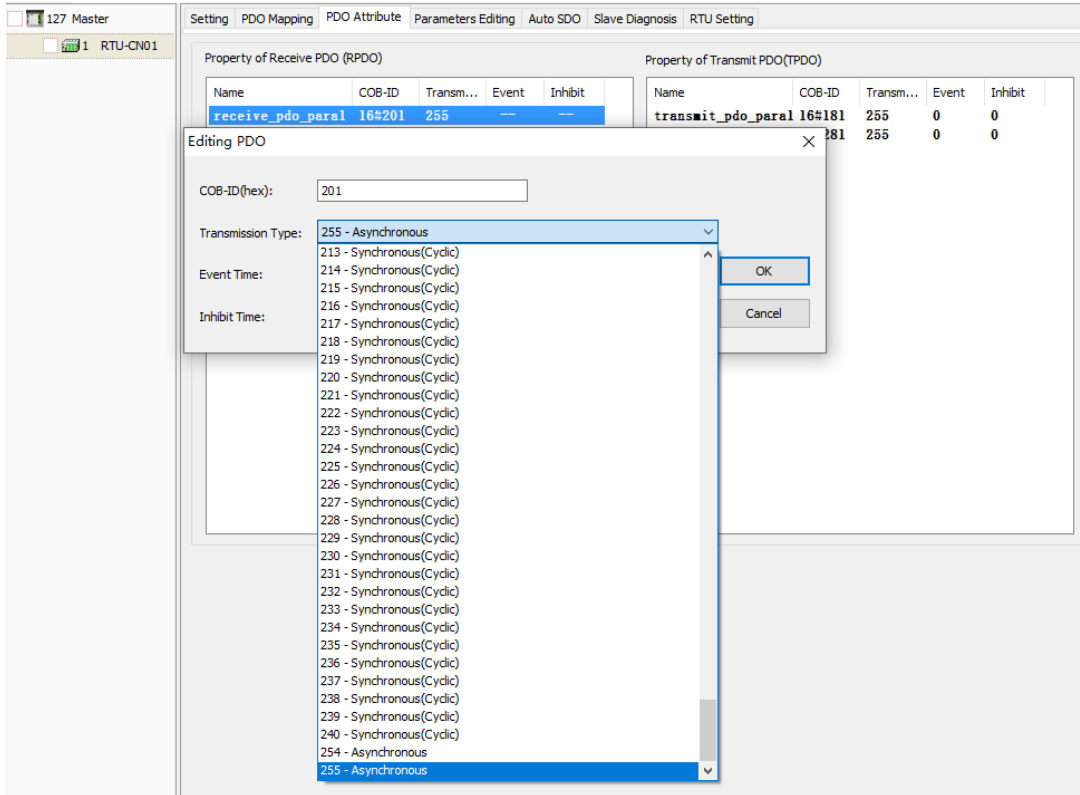

5

5.3.3 Adding RTU-CN01 Configuration to Node Configuration List

Here are the steps to add RTU-CN01 configuration to Node List:
 Click on “127 Master”, come to the “Node List” tab interface and then select the box beside RTU-CN01 symbol or use  button to add RTU-CN01 to the node list.

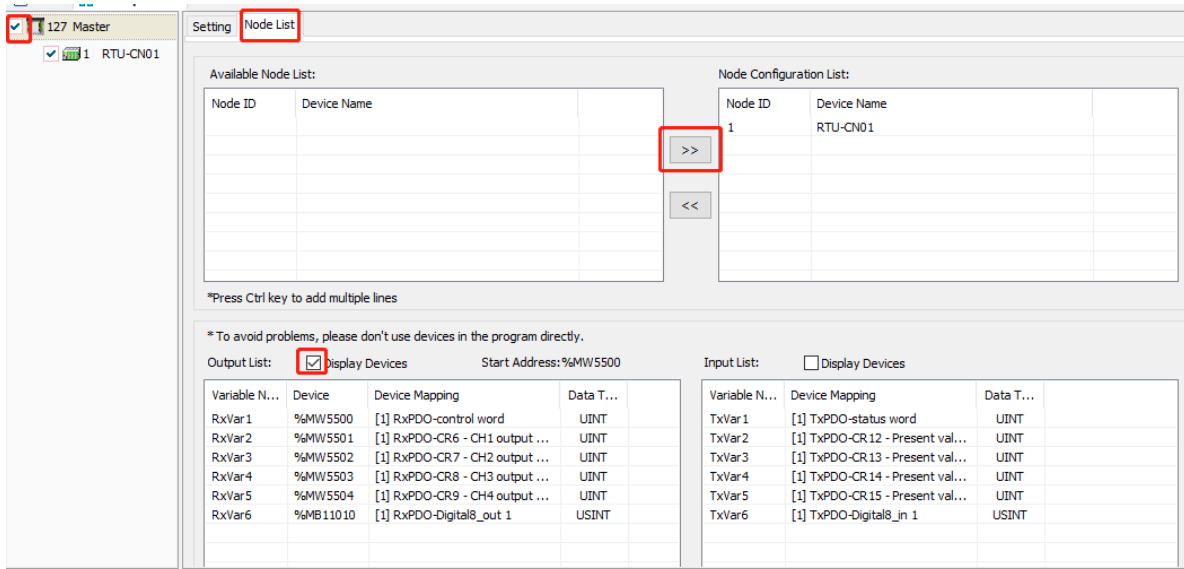

Explanation of Node List Interface:

Item	Description
Available Node List	The list of slaves which can be configured to the master
Node Configuration List	The list of slaves which have already been configured to the master
Node ID	Node address of a slave
Device Name	Slave name
Output List	The mapping list of master output variables and devices and corresponding slave parameters
Input List	The mapping list of master input variables and devices and corresponding slave parameters
Variable Name	The name of a master variable which corresponds to a slave parameter
Device Mapping	Slave parameters which have been configured
Data Type	The data type of a slave parameter which corresponds to a master variable and device.
Display Devices	If the item is selected, the master devices which slave parameters correspond to are displayed. If not selected, they are hidden.

MEMO

Chapter 6 Introduction of Parameters and PDO Transmission Types

Table of Contents

6.1 Parameters from EDS File	6-2
6.2 PDO Transmission Types.....	6-8

6.1 Parameters from EDS File

- Parameters for digital modules on the right side of RTU-CN01

16#6000 and 16#6200 are parameters for digital modules on the right side of RTU-CN01. The index 16#6000 is the index for configuring input points. It contains 16 subindexes. Each subindex is configured with 8 input points. Subindex 1 corresponds to the 1st 8 point input of digital modules on the right side of RTU-CN01, subindex 2 corresponds to the 2nd 8 point input of digital modules on the right side of RTU-CN01 and so on. Subindex 16 corresponds to the 16th 8 point input of digital modules on the right side of RTU-CN01. Up to 128 input points can be configured in total.

The index 16#6200 is the index for configuring output points. It contains 16 subindexes. Each subindex is configured with 8 output points. Subindex 1 corresponds to the 1st 8 point output of digital modules on the right side of RTU-CN01, subindex 2 corresponds to the 2nd 8 point output of digital modules on the right side of RTU-CN01 and so on. Subindex 16 corresponds to the 16th 8 point output of digital modules on the right side of RTU-CN01. Up to 128 output points can be configured in total.

For example, there is one DVP16SN11T and one DVP16SM11T on the right side of RTU-CN01. And there are 16 output points and 16 input points in total. Each subindex for input or output configuration can be configured with 8 points and thus 2 subindexes are needed for the configuration of input points. That is, the index 16#6000 and subindex 16#1 correspond to X0~X7 of DVP16SM11T and index 16#6000 and subindex 16#2 correspond to X10~X17 of DVP16SM11T. To configure the output points, the index 16#6200 and subindex 16#1, which correspond to Y0~Y7 of DVP16SN11T and the index 16#6200 and subindex 16#2, which correspond to Y10~Y17 of DVP16SN11T are used in the same way.

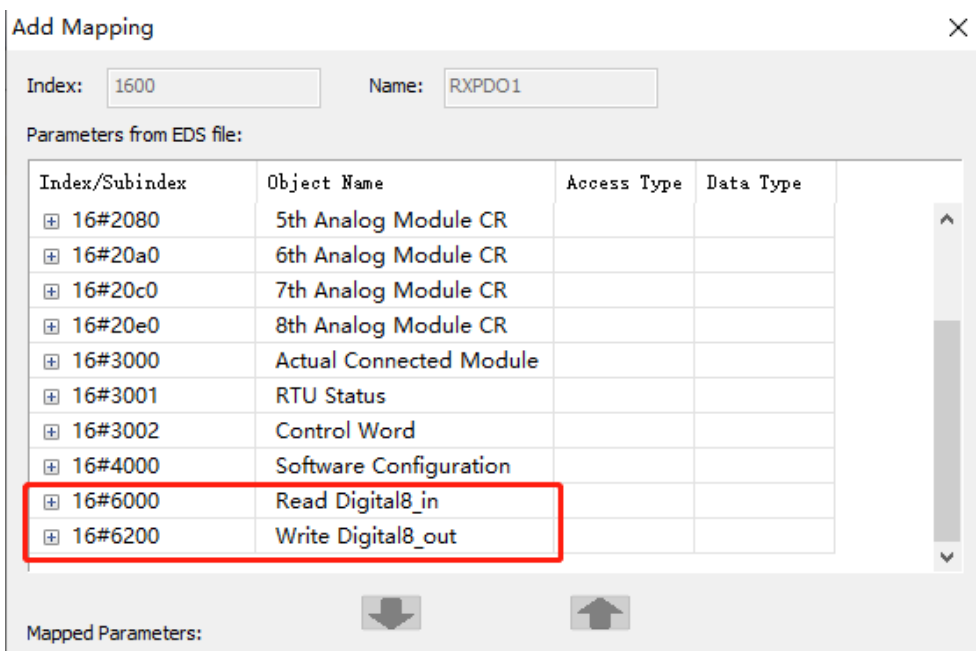

- Parameters for special modules on the right side of RTU-CN01

The following 16#2000~16#20e0 are parameters for the special modules on the right of RTU-CN01. The index 16#2000 is the index of the 1st special module on the right of RTU-CN01, 16#2020 is the index of the 2nd special module on the right of RTU-CN01 and so on. So in the same way, 16#20e0 is the index of the 8th analog module on the right of RTU-CN01.

Parameters from EDS file:

Index/Subindex	Object Name	Access Type	Data Type
⊕ 16#2000	1st Analog Module CR		
⊕ 16#2020	2nd Analog Module CR		
⊕ 16#2040	3rd Analog Module CR		
⊕ 16#2060	4th Analog Module CR		
⊕ 16#2080	5th Analog Module CR		
⊕ 16#20a0	6th Analog Module CR		
⊕ 16#20c0	7th Analog Module CR		
⊕ 16#20e0	8th Analog Module CR		

For a special module, its index includes 49 subindexes which correspond to CRs of the special module respectively. As shown below, the subindexes of the index 16#2000 correspond to CRs of the 1st special module on the right of RTU-CN01 respectively. E.g. index 16#2000 and subindex 16#1 correspond to CR0 of the 1st analog module on the right of RTU-CN01. Index 16#2000 and subindex 16#7 correspond to CR6 of the 1st analog module on the right of RTU-CN01.

The parameters which are to be configured in RxPDO or TxPDO are selected according to the access types (read/write) of the CR registers of the right module of RTU-CN01. E.g. the input values of four channels (CR12~CR15, read only) of DVP04AD-S on the right of RTU-CN01 need be configured in TxPDO.

Parameters from EDS file:

Index/Subindex	Object Name	Access Type	Data Type
⊖ 16#2000	1st Analog Module CR		
16#1	1st Module CR0	rw	UINT
16#2	1st Module CR1	rw	UINT
16#3	1st Module CR2	rw	UINT
16#4	1st Module CR3	rw	UINT
16#5	1st Module CR4	rw	UINT
16#6	1st Module CR5	rw	UINT
16#7	1st Module CR6	rw	UINT
16#8	1st Module CR7	rw	UINT
16#9	1st Module CR8	rw	UINT

- Parameter for the actual connection state of the modules on the right side of RTU-CN01

Index 16#3000 is the parameter that shows the actual connection state of the modules on the right of RTU-CN01.

Parameters from EDS file:

Index/Subindex	Object Name	Access Type	Data Type
16#3000	Actual Connected Module		
16#1	Analog Module Number	ro	USINT
16#2	Number of Input points	ro	USINT
16#3	Number of Output points	ro	USINT
16#4	1st Analog Module Code	ro	UINT
16#5	2nd Analog Module Code	ro	UINT
16#6	3rd Analog Module Code	ro	UINT
16#7	4th Analog Module Code	ro	UINT
16#8	5th Analog Module Code	ro	UINT
16#9	6th Analog Module Code	ro	UINT
16#A	7th Analog Module Code	ro	UINT

Explanation of parameters above:

Index	Subindex	Description	Data Type	Access Type	Range
0x3000	1	Number of special modules	UINT8	RO	0~8
	2	Number of input points	UINT8	RO	0~128
	3	Number of output points	UINT8	RO	0~128
	4	Module code of the 1 st special module	UINT16	RO	Model code
	5	Module code of the 2 nd special module	UINT16	RO	Model code
	6	Module code of the 3 rd special module	UINT16	RO	Model code
	7	Module code of the 4 th special module	UINT16	RO	Model code
	8	Module code of the 5 th special module	UINT16	RO	Model code
	9	Module code of the 6 th special module	UINT16	RO	Model code
	A	Module code of the 7 th special module	UINT16	RO	Model code
	B	Module code of the 8 th special module	UINT16	RO	Model code

- Parameter for the state of RTU-CN01

Index 16#3001 is the parameter for showing the state of RTU-CN01.

Parameters from EDS file:

Index/Subindex	Object Name	Access Type	Data Type
16#3001	RTU Status		
16#1	status word	ro	UINT
16#2	Error Module Number	ro	USINT
16#3	1st Module Error Code	ro	UINT
16#4	2nd Module Error Code	ro	UINT
16#5	3rd Module Error Code	ro	UINT
16#6	4th Module Error Code	ro	UINT
16#7	5th Module Error Code	ro	UINT
16#8	6th Module Error Code	ro	UINT
16#9	7th Module Error Code	ro	UINT
16#A	8th Module Error Code	ro	UINT

Explanation of parameters above:

Index	Subindex	Description	Data Type	Access Type
0x3001	1	Status Word	UINT16	RO
	2	Number of special modules in error	UINT8	RO
	3	The error code of the 1 st special module	UINT16	RO
	4	The error code of the 2 nd special module	UINT16	RO
	5	The error code of the 3 rd special module	UINT16	RO
	6	The error code of the 4 th special module	UINT16	RO
	7	The error code of the 5 th special module	UINT16	RO
	8	The error code of the 6 th special module	UINT16	RO
	9	The error code of the 7 th special module	UINT16	RO
	A	The error code of the 8 th special module	UINT16	RO
	B	The state of the 1 st special module	UINT8	RO
	C	The state of the 2 nd special module	UINT8	RO
D	The state of the 3 rd special module	UINT8	RO	
E	The state of the 4 th special module	UINT8	RO	
F	The state of the 5 th special module	UINT8	RO	
10	The state of the 6 th special module	UINT8	RO	
11	The state of the 7 th special module	UINT8	RO	
12	The state of the 8 th special module	UINT8	RO	

Note:

For error codes of special modules, see error status CRs in DVP-PLC Application Manual: Special Modules (S/H2 Series).

See the table below for the meanings of special module status values:

Special module state		
B0	0	The communication between RTU-CN01 and the special modules on its right communicate is normal.
	1	The communication between RTU-CN01 and the special modules on its right fails.
B1	0	The special modules are working normally.
	1	An error occurs in special modules.
B2	0	The special modules on the right of RTU-CN01 are the same as configured in the software.
	1	The special modules on the right of RTU-CN01 are different from those configured in the software.
B3	0	Valid data in the software
	1	Invalid data configured in the software
B4	0	RTU-CN01 can identify the special modules on its right side.
	1	RTU-CN01 fails to identify the special module on its right side.
B5~b7		Reserved

- Control Word

Index 16#3002 and subindex 1 are control word parameters. See Section 5.2.4 for details on the control word and state word of RTU-CN01.

- Software-configured Parameters

Index 16#4000 refers to the relevant parameters configured by the software.

6

Parameters from EDS file:

Index/Subindex	Object Name	Access Type	Data Type
16#4000	Software Configuration		
16#1	CfgParaEnable	rw	USINT
16#2	Diagnosis Interval Time	rw	USINT
16#3	IO Module Offline Treat...	rw	USINT
16#4	IO Module Error Treatm...	rw	USINT
16#5	Configured Module Num...	rw	UINT
16#6	1st Configured Module C...	rw	UINT
16#7	2nd Configured Module ...	rw	UINT
16#8	3rd Configured Module ...	rw	UINT
16#9	4th Configured Module C...	rw	UINT
16#...	5th Configured Module C...	rw	UINT

Explanation of parameters:

Index	Subindex	Object Name	Meaning	Data Type	Access Type	Meaning
0x4000	1	CfgParaEnable	Configured parameters enabled	UINT8	RW	0: Enabled before the next RTU configuration download after RTU configuration is reset. 1: Enabled after RTU configuration is downloaded.
	2	Diagnosis Interval Time	Interval time for diagnosis	UINT8	RW	The time interval for the diagnosis of the special modules on the right of RTU-CN01. Unit: second.
	3	IO Module OfflineTreatment	How to deal with the IO module offline	UINT8	RW	IO module offline/error treatment 0: Ignore 1: Alarm
	4	IO Module Error Treatment	How to deal with the error in IO modules	UINT8	RW	
	5	Configured Module Number	The number of special modules which have been configured	UINT8	R/W	The number of configured special modules; Range: 0~8
	6	1st Configured Module Code	The model code of the 1 st special module which has been configured	UINT16	RW	It is 16#88 when 04AD is configured. It is 16#89 when 04DA is configured.
	7	2nd Configured Module Code	The model code of the 2 nd special module which has been configured	UINT16	RW	
	8	3rd Configured Module Code	The model code of the 3 rd special module which has been configured	UINT16	RW	
	9	4th Configured Module Code	The model code of the 4 th special module which has been configured	UINT16	RW	
	A	5th Configured Module Code	The model code of the 5 th special module which has been configured	UINT16	RW	
	B	6th Configured Module Code	The model code of the 6 th special module which has been configured	UINT16	RW	

Index	Subindex	Object Name	Meaning	Data Type	Access Type	Meaning
	C	7th Configured Module Code	The model code of the 7 th special module which has been configured	UINT16	RW	
	D	8th Configured Module Code	The model code of the 8 th special module which has been configured	UINT16	RW	
	E	Reset RTU	Reset RTU-CN01	UINT8	R/W	0: Ineffective 1: RTU-CN01 is reset.

6.2 PDO Transmission Types

- See the following table for the explanation of PDO transmission types.

Transmission type	Description	Remark
0	<p>RxPDO: The master transmits a SYNCH message to the slave every SYNCH cycle. When there is change for RxPDO data and RxPDO data is transmitted to the slave, the data that the slave receives is valid after receiving the next SYNCH message. When there is no change for RxPDO data, the master does not transmit RxPDO data to the slave.</p> <p>TxPDO: The master transmits a SYNCH message to the slave every SYNCH cycle. When TxPDO data changes and the slave sends the TxPDO data to the master after receiving SYNCH message, TxPDO data that the master receives is valid immediately. When there is no change for TxPDO data, the slave does not transmit TxPDO data to the master.</p>	SYNCH non-cyclical
1~253	<p>RxPDO: The master transmits a SYNCH message to the slave every SYNCH cycle. The master sends out RxPDO data to the slave once every 1~253 SYNCH cycle(s). The RxPDO data that the slave receives from the master is valid after it receives the next SYNCH message.</p> <p>TxPDO: The master transmits a SYNCH message to the slave every SYNCH cycle. The slave sends out TxPDO data to the master once every time it receives 1~253 SYNCH message (s). And the TxPDO data the master receives is valid immediately.</p>	SYNCH Cyclical
254	<p>RxPDO: Same as transmission type 255</p> <p>TxPDO: Same as transmission type 255</p>	ASYNCH
255	<p>RxPDO: When there is a change for RxPDO, the RxPDO data is transmitted to the slave and the data that the slave receives is valid immediately. When there is no change for RxPDO, the master does not send RxPDO data to the slave.</p>	ASYNCH

Transmission type		Description	Remark
	TxPDO	<p>When the values of Event timer and inhibit timer are both 0, TxPDO data is transmitted to the master after TxPDO data changes and the data that the master receives is valid immediately. When TxPDO data does not change, the slave does not send out TxPDO data to the master.</p> <p>When neither of Event timer and inhibit timer are 0, the slave sends out TxPDO data to the master once every a period of Event timer. After TxPDO data is sent out once, no TxPDO data is allowed to be sent out within the period of inhibit timer. And TxPDO data is transmitted to the master immediately once TxPDO data changes and the data that master receives is valid immediately.</p>	

MEMO

Chapter 7 Application Examples

Table of Contents

7.1 Configuring RTU-CN01 Parameters via CANopen Builder	7-3
7.1.1 Configuring RTU-CN01 Module	7-3
7.1.2 Downloading Configuration to CANopen Master	7-9
7.1.3 Program Control over RTU-CN01 in the CANopen Network.....	7-11
7.2 Example of Using RTU-CN01 with Non-Delta Master Together ..	7-14
7.2.1 Setting Baud Rate	7-14
7.2.2 Importing EDS File of RTU-CN01	7-16
7.2.3 Adding the Remote Terminal RTU-CN01	7-16
7.2.4 Configuring CANopen Remote Device Parameters.....	7-19
7.2.5 Configuring PDO Mappings	7-19

This part describes how to configure RTU-CN01 module parameters with examples. DVP04DA-S, DVP04AD-S and DVP16SP11T on the right side of RTU-CN01 are controlled through PDO mapping on the RTU configuration software interface in Section 7.1.

In Section 7.2, the right-side modules are controlled through PDO mapping by using a master from other vendor together with RTU-CN01.

■ Control requirement:

1. The states of X0~X7 of DVP16SP11T and present values of channel 1~channel 4 of DVP04AD-S are monitored in real time.
2. When D_OUT=ON for DVP50MC CPU, Y0~Y7 of DVP16SP11T change to ON. When D_OUT=OFF for DVP50MC CPU, Y0~Y7 of DVP16SP11T change to OFF.
3. When DA=ON, channel 1 of DVP04DA-S outputs 2.50V and channel 2 outputs 5V. When DA=OFF, channel 1 and channel 2 of DVP04DA-S output 0V voltage.

■ Constructing a CANopen network via RTU-CN01

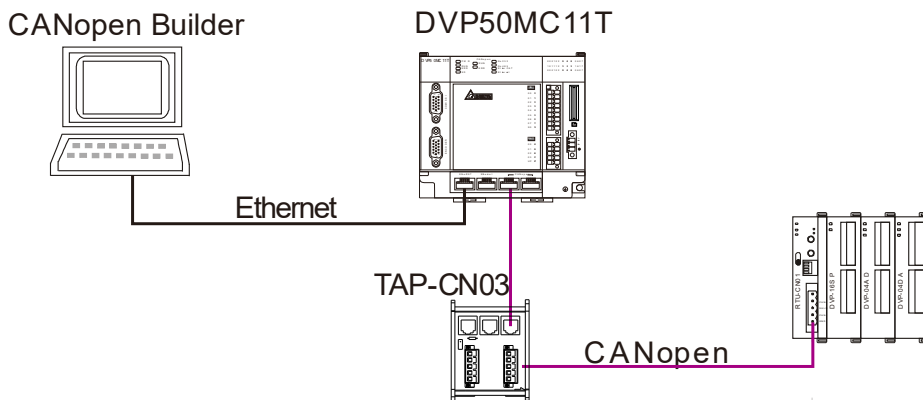

Note:

The terminal resistor of 120Ω should be connected between CAN_H and CAN_L of two respective ends of the network.

■ Devices used in this example

Device name	Description
DVP50MC11T	Delta PLC CPU
RTU-CN01	Delta CANopen remote IO module
DVP04DA-S	Delta analog output module
DVP04AD-S	Delta analog input module
DVP16SP11T	Delta digital input and output modules with 8 input points and 8 output points

■ Setup for the field modules

Module name	CANopen node address	CANopen baud rate
DVP50MC11T	127	1M
RTU-CN01	1	1M

7.1 Configuring RTU-CN01 Parameters via CANopen Builder

7.1.1 Configuring RTU-CN01 Module

1. Start CANopen Builder and then see the software window as below.

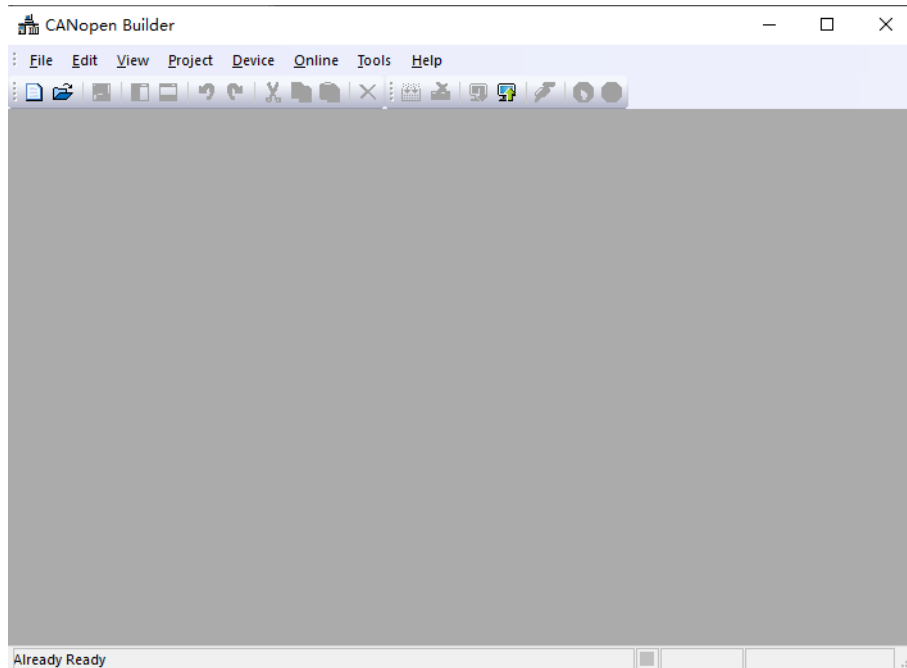

2. Click on “New Project” button and then select “DVP50MC11T” in the window which pops up.

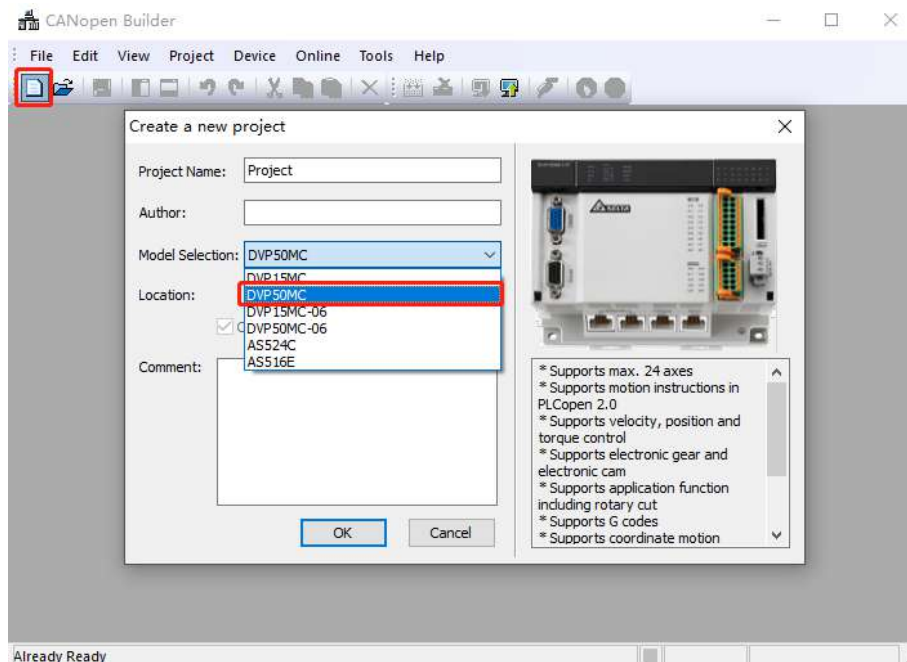

3. Then click on “OK” button to return to the main interface. Click on the symbol “+” on the left of “Network Configuration” to unfold the network configuration. Then double-click on “CANopen” to make the CANopen configuration window appear.

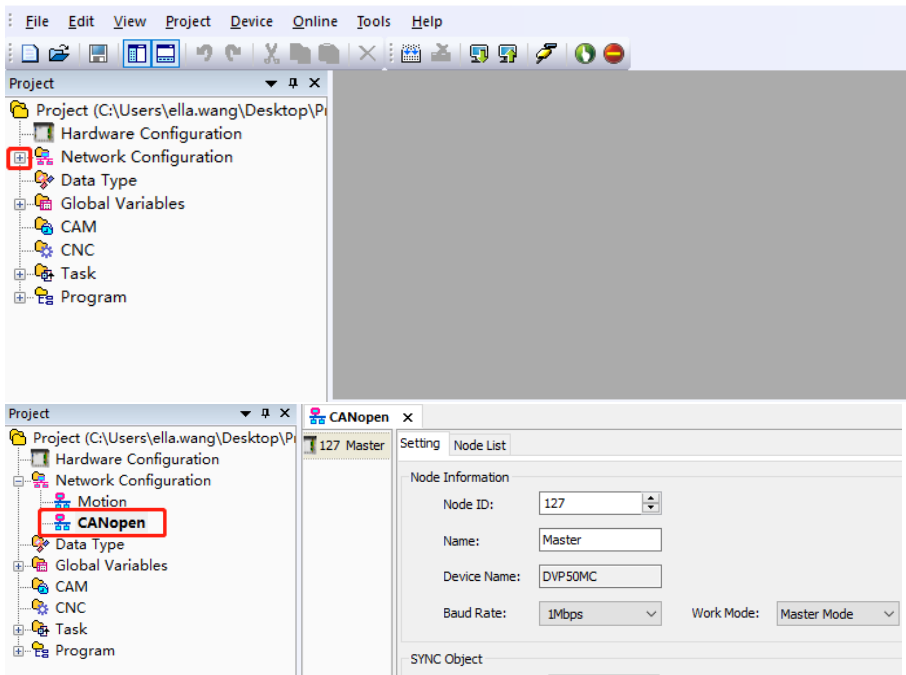

- Right click on “127Master” and then select “Add Device” from the context menu. You can also select “Scan Network” to scan all connected slaves.

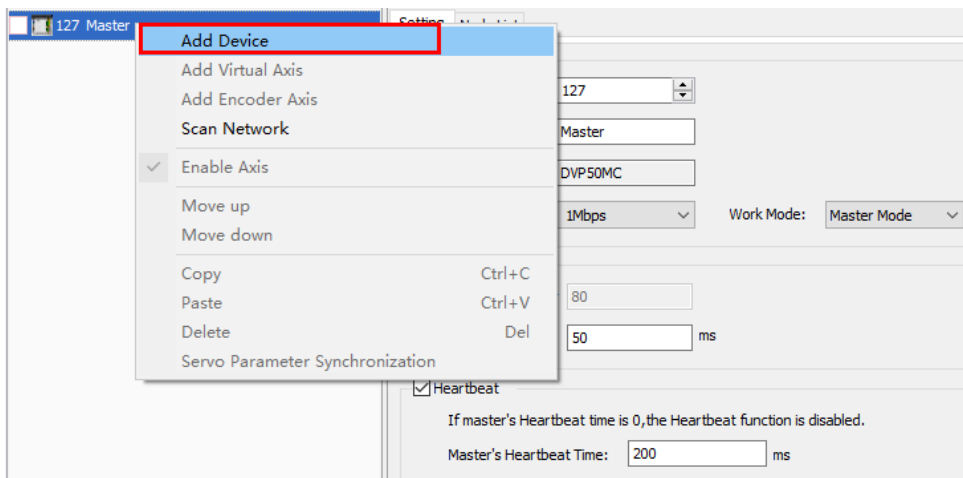

- By clicking on “Add Device”, the following dialog box appears, where you should find out and select RTU-CN01 and then click “Add” button.

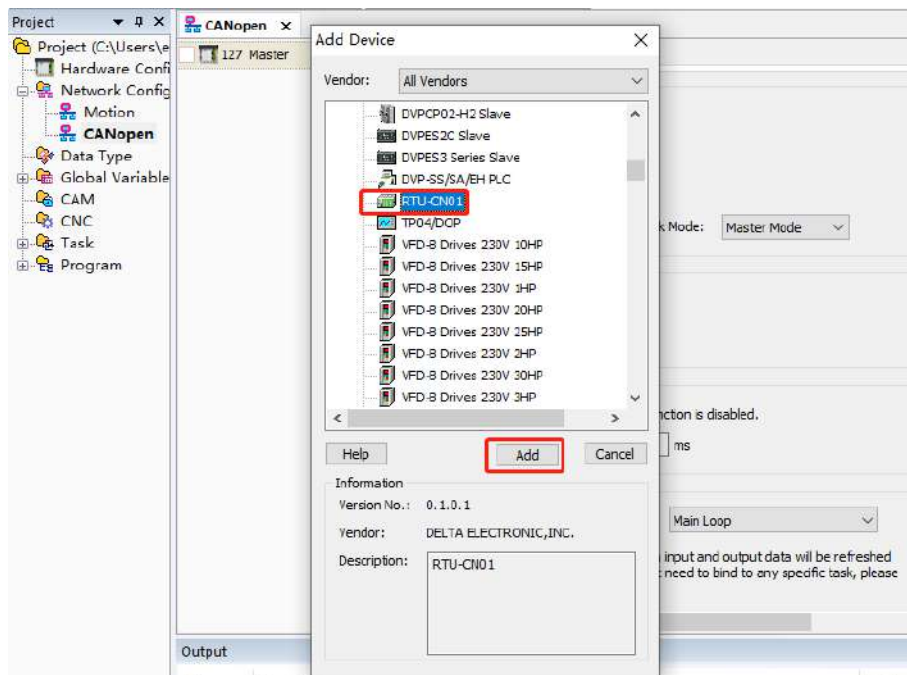

- Click on the slave RTU-CN01 and then on “RTU Setting”. You will see the RTU configuration interface as below.



- Click on “Scan IO” button and then see the following dialog.

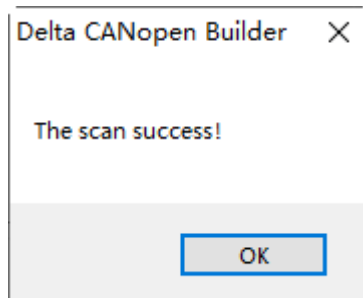

- Click on “OK” button. CANopen Builder will detect special modules and the number of points of digital modules and show them on the “RTU Setting” tab page.

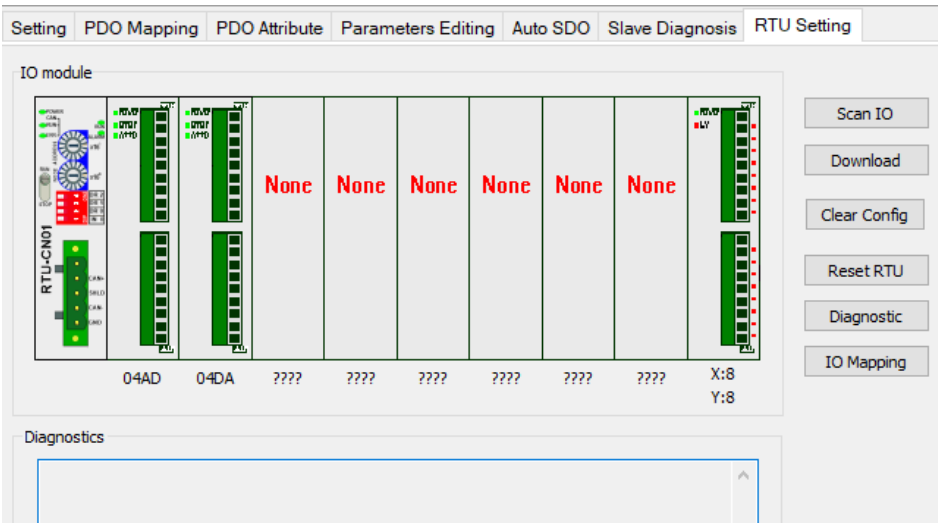

- With a double-click on “04AD” symbol, the “Special Module Configuration” dialog appears. Four channels of present values for 04AD module are configured to be sent to the master. For detailed explanation, refer to Section 5.2.3. Click “OK” to finish the configuration.

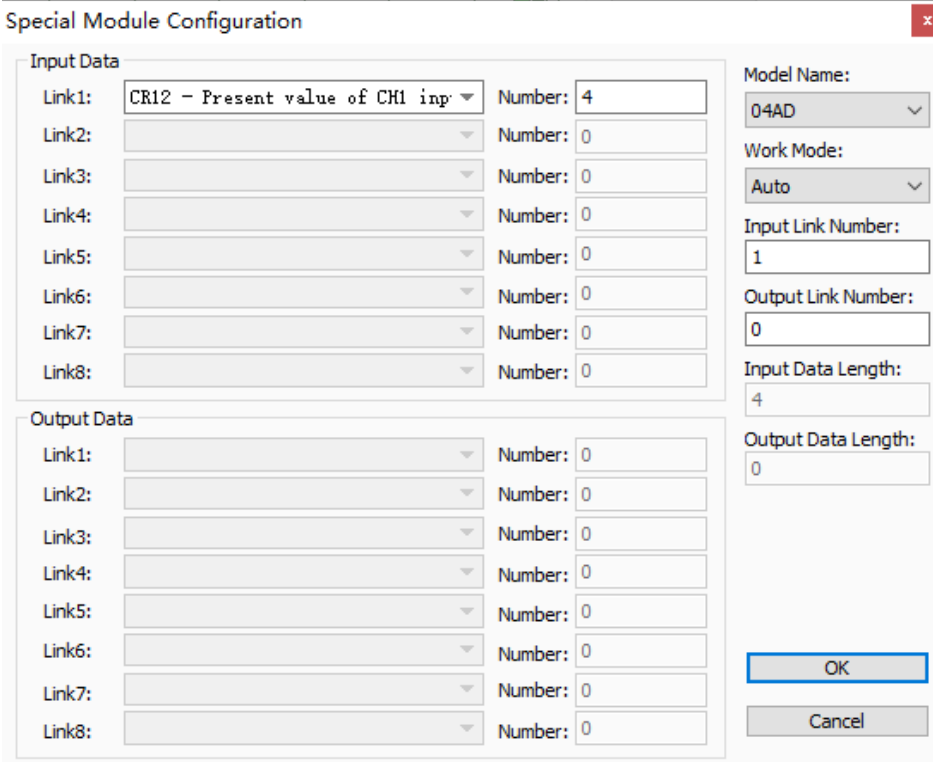

Note:

No matter whether the work mode is auto mode or custom mode, be sure to click “OK” to make the configuration effective after special modules are configured.

10. With a double-click on “04DA” symbol, the “Special Module Configuration” dialog box appears, where you select “Custom” as the work mode to reset the configuration of 04DA module. Click on “OK” button to finish the configuration.

Special Module Configuration

Input Data		Model Name:	
Link1:	<input type="text"/>	Number:	<input type="text" value="0"/>
Link2:	<input type="text"/>	Number:	<input type="text" value="0"/>
Link3:	<input type="text"/>	Number:	<input type="text" value="0"/>
Link4:	<input type="text"/>	Number:	<input type="text" value="0"/>
Link5:	<input type="text"/>	Number:	<input type="text" value="0"/>
Link6:	<input type="text"/>	Number:	<input type="text" value="0"/>
Link7:	<input type="text"/>	Number:	<input type="text" value="0"/>
Link8:	<input type="text"/>	Number:	<input type="text" value="0"/>

Output Data		Work Mode:	
Link1:	CR8 - CH1 output value	Number:	<input type="text" value="4"/>
Link2:	<input type="text"/>	Number:	<input type="text" value="0"/>
Link3:	<input type="text"/>	Number:	<input type="text" value="0"/>
Link4:	<input type="text"/>	Number:	<input type="text" value="0"/>
Link5:	<input type="text"/>	Number:	<input type="text" value="0"/>
Link6:	<input type="text"/>	Number:	<input type="text" value="0"/>
Link7:	<input type="text"/>	Number:	<input type="text" value="0"/>
Link8:	<input type="text"/>	Number:	<input type="text" value="0"/>

Input Link Number:	<input type="text" value="0"/>
Output Link Number:	<input type="text" value="1"/>
Input Data Length:	<input type="text" value="0"/>
Output Data Length:	<input type="text" value="4"/>

Model Name: 04DA

Work Mode: Auto

OK

Cancel

11. The “Digital Input/Output Points” interface appears by double-clicking on the symbol of digital modules on the rightmost side of RTU-CN01. Click “OK” to finish the configuration.

Setting PDO Mapping PDO Attribute Parameters Editing Auto SDO Slave Diagnosis RTU Setting

IO module

RTU-CN01

Digital Input/Output Points

Digital Input/Output Points

Digital Input Points(X):

Digital Output Points(Y):

OK

Cancel

Scan IO

Download

Clear Config

Reset RTU

Diagnostic

IO Mapping

By double-clicking “RTU-CN01” symbol, the “RTU Setting” dialog box appears. Refer to Section 5.2.2 for details.

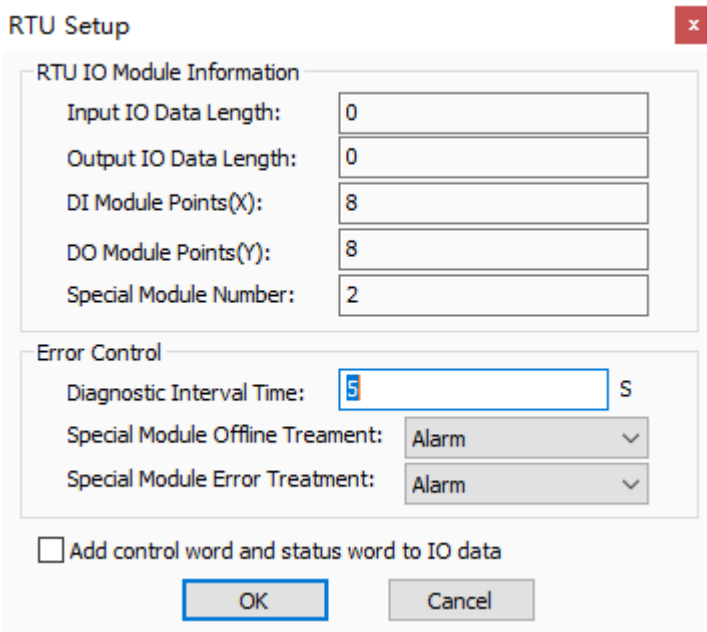

- When the setting is complete, click “OK” to return to the RTU setting interface. After you have confirmed that the settings are correct, click “Download” button to download the configuration to the RTU-CN01 module on the interface of RTU-CN01 Setting. Then click “OK” to finish the download.

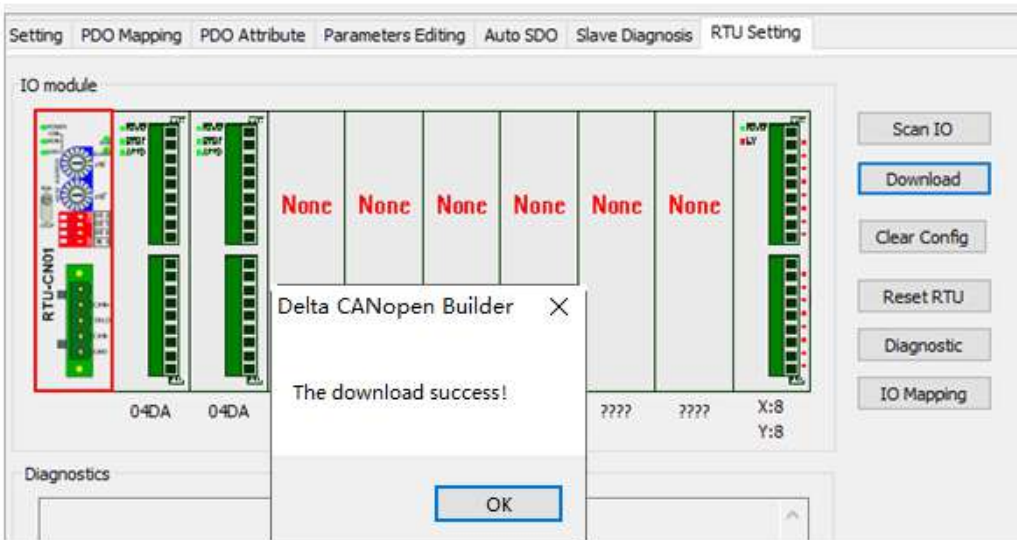

- Click “Add SDO” button on the “Auto SDO” tab page. Choose the index 16#2000 since DVP04AD-S is the first module on the right of RTU-CN01. Choose the subindex 16#2 since CR1 is the parameter for input mode setting.
To set the input modes to mode 0 for channel 1 ~ channel 4, fill 16#0 in the “Data” field. Click “Add” to finish the setting.

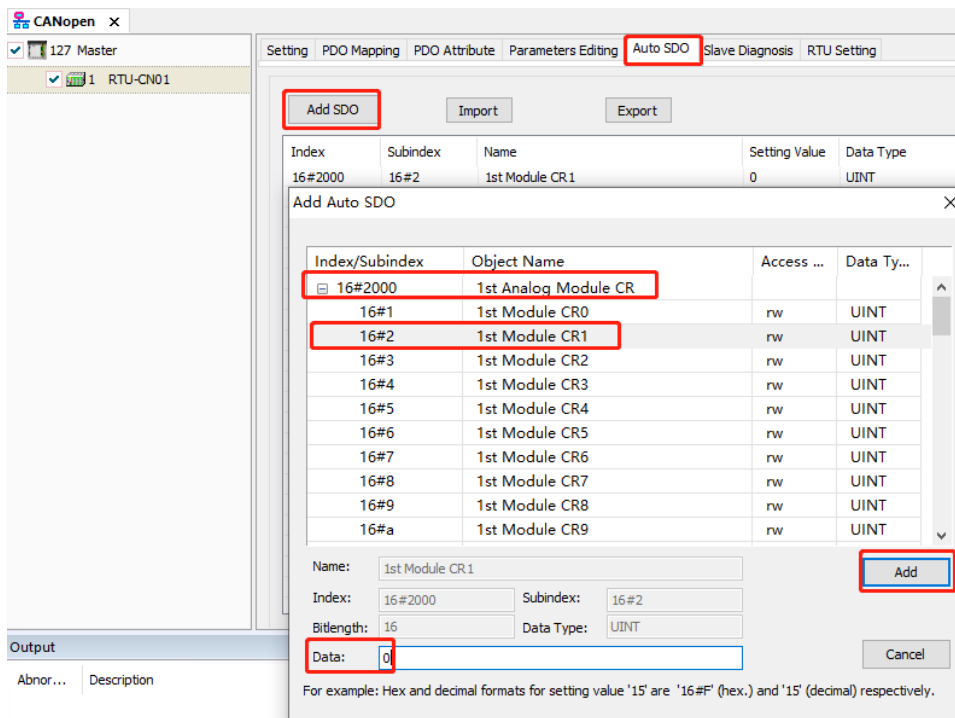

7.1.2 Downloading Configuration to CANopen Master

1. Click on “127Master” symbol on the CANopen configuration interface and then click on “Node List” tab. On the “Node List” tab page, you see the available node RTU-CN01 is on the left and “Node Configuration List” is on the right in “Available Node List” area.

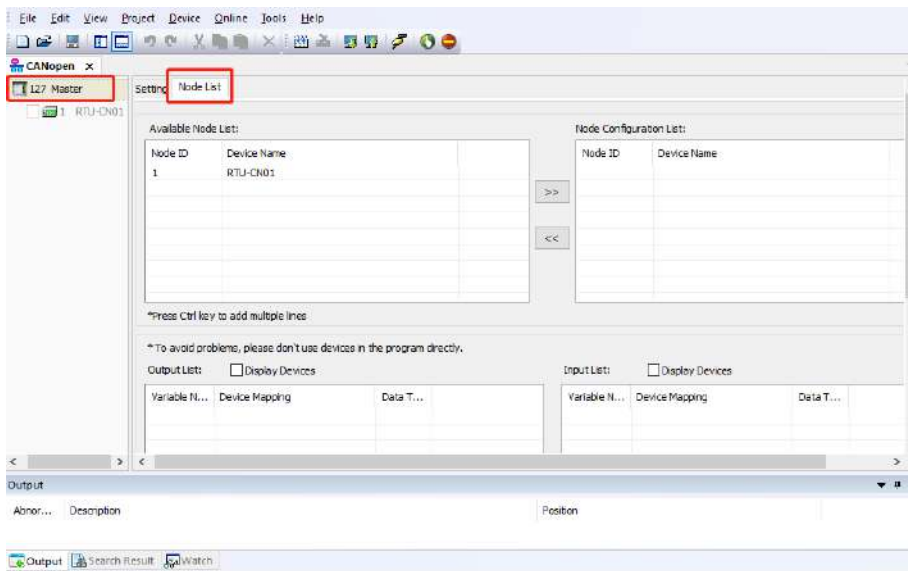

2. Add the CANopen slave device on the left to the node configuration list on the right of the “Node List” tab page by selecting the CANopen slave node and then clicking “>>”. The CANopen slave node is added to the node configuration list of the “Node List” tab by doing so.

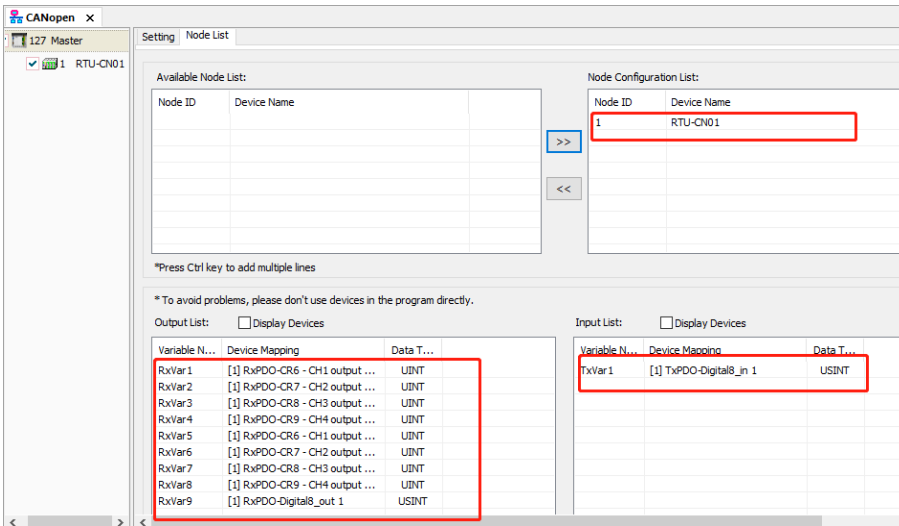

Note: Variable names in “Output List” and “Input List” can be modified manually.

- Then click on to download the configuration to CANopen master DVP50MC. During the download, a reminder dialog will appear if 50MC is in RUN state as below. Just click “Y” button to download the configuration to the master DVP50MC.

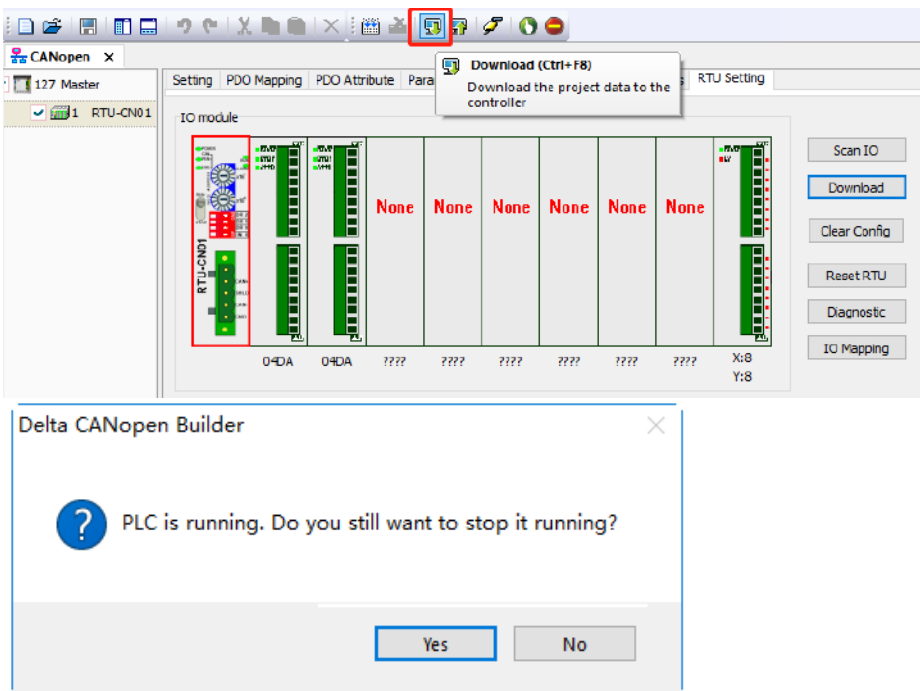

- After the download is complete, the following dialog appears to remind whether to restart the PLC. Select “Yes” to have DVP50MC enter the RUN state.

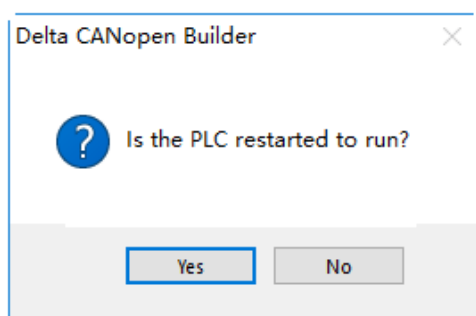

5. When “RUN” and “CAN RUN” indicators of RTU-CN01 are in green and “CAN” indicator of DVP50MC is also in green, it means that the master and slave have managed to make a connection and then the IO data exchange can be carried out through PDO.

7.1.3 Program Control over RTU-CN01 in the CANopen Network

- IO data mapping between master PLC and RTU-CN01

- Controller → RTU-CN01 slave

Master variable name	CANopen bus data transmission	Slave parameter index	Slave parameter subindex	Slave parameter	Meaning of slave parameters
RxVar1	➔	16#2020	16#7	CR6 of the 2 nd module on the right of RTU-CN01	DVP04DA's channel 1 setting value
RxVar2		16#2020	16#8	CR7 of the 2 nd module on the right of RTU-CN01	DVP04DA's channel 2 setting value
RxVar3		16#6200	16#1	8 points of digital output	DVP16SP's output Y0~Y7

■ RTU-CN01 slave → Controller

Master variable name	CANopen bus data transmission	Slave parameter index	Slave parameter subindex	Slave parameter	Meaning of slave parameters
TxVar1	←	16#2000	16#d	CR12 of the 1 st module on the right of RTU-CN01	DVP04AD's channel 1 present value
TxVar2		16#2000	16#e	CR13 of the 1 st module on the right of RTU-CN01	DVP04AD's channel 2 present value
TxVar3		16#2000	16#f	CR14 of the 1 st module on the right of RTU-CN01	DVP04AD's channel 3 present value
TxVar4		16#2000	16#10	CR15 of the 1 st module on the right of RTU-CN01	DVP04AD's channel 4 present value
TxVar5		16#6000	16#1	8 points of digital input	DVP16SP's input X0~X7

7

● **CANopen Network Control**

■ **【Master PLC Control Program】**

Index	Scope	Name	Address	Data Type	Initial Value	Comment
1	VAR	DA		BOOL		
2	VAR	AD		BOOL		
3	VAR	AD_CH		INT		
4	VAR	AD_CH		INT		
5	VAR	AD_CH		INT		
6	VAR	AD_CH		INT		
7	VAR	D_OUT		BOOL		
8	VAR	D_IN		BOOL		
9	VAR	SP_IN		INT		

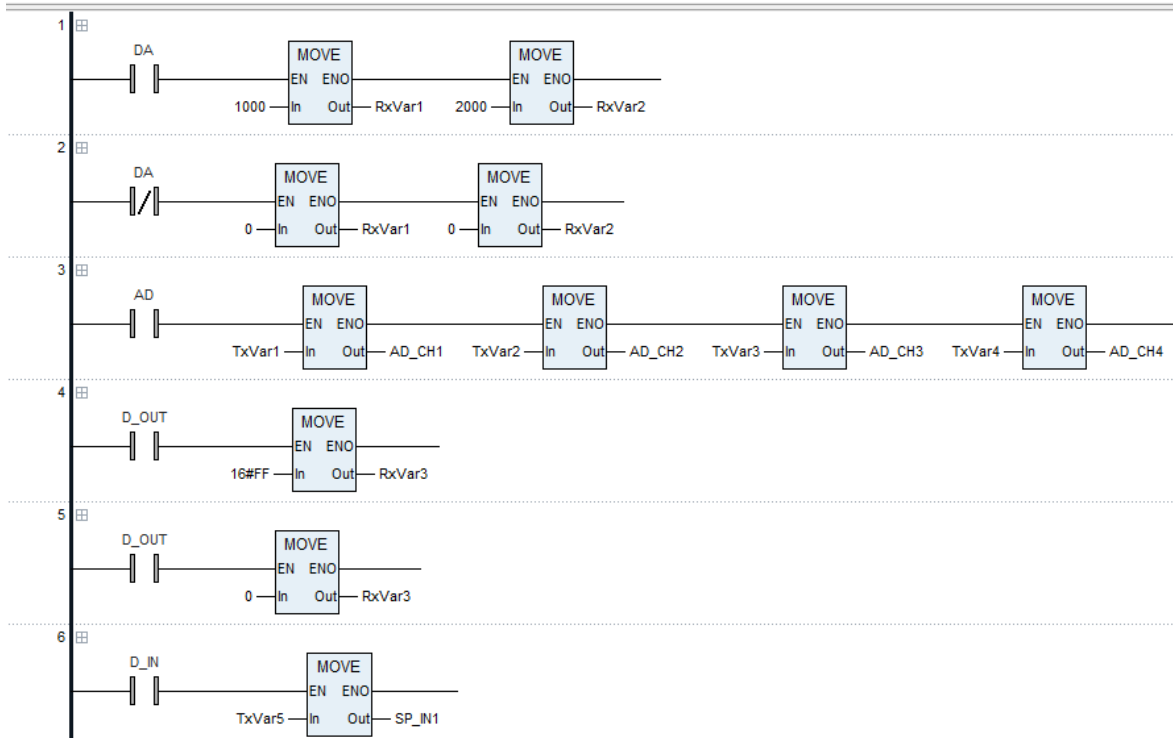

Program explanation

- When DA is TRUE, the value of RxVar1 is 1000, DVP04DA's channel 1 outputs 2.5V voltage, the value of RxVar2 is 2000 and DVP04DA's channel 2 outputs 5V voltage.
When DA is FALSE, the values of RxVar1 and RxVar2 are both 0 and DVP04DA's channel 1 and channel 2 both output 0V voltage.
- When AD is TRUE, TxVar1~TxVar4 are assigned to AD_CH1~AD_CH4 to read the present values of channel 1~ channel 4 of DVP04AD-S.
- When D_OUT=ON, the value of RxVar3 is 16#FF (255) and DVP16SP11T is controlled to change its Y0~Y7 to ON.
When D_OUT=OFF, the value of RxVar3 is 0 and DVP16SP11T is controlled to change its Y0~Y7 to OFF.
- When D_IN=ON, TxVar5 is assigned to SP_IN1 to read the values of DVP16SP's input points X0~X7.

- See the following diagrams for the digital - analog relations for DVP04DA-S and DVP04AD-S.

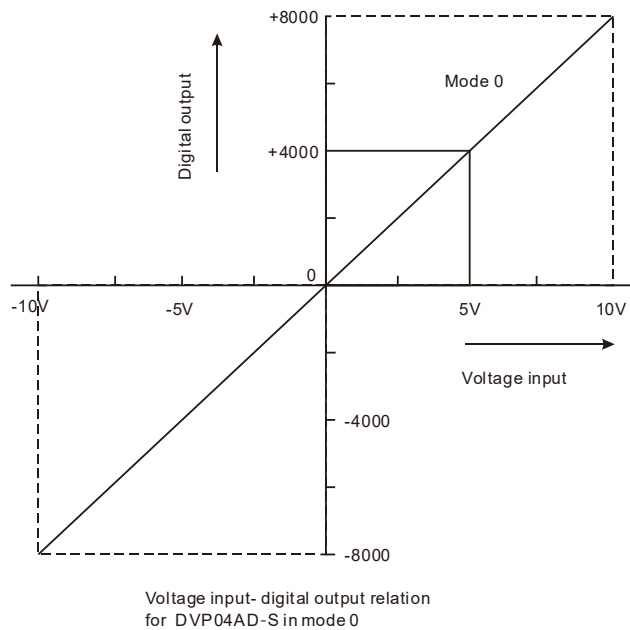
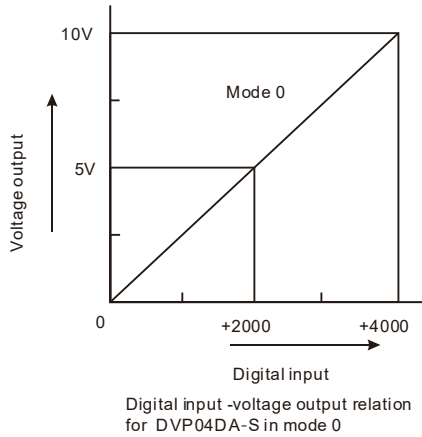

7

7.2 Example of Using RTU-CN01 with Non-Delta Master Together

Here the third-party software (Schneider) is used to directly configure the PDO parameters which are used in section 7.1 in the PDO mapping window. You can learn from this section about how to configure RTU-CN01-related parameters via the third-party software.

7.2.1 Setting Baud Rate

The CANbus page appears with a click on “CAN0”, where the baud rate is set. Please ensure that the baud rate of the master must be the same as that of acutally connected RTU-CN01.

For the baud rate setup of RTU-CN01, refer to Function Switch in Section 2.6.

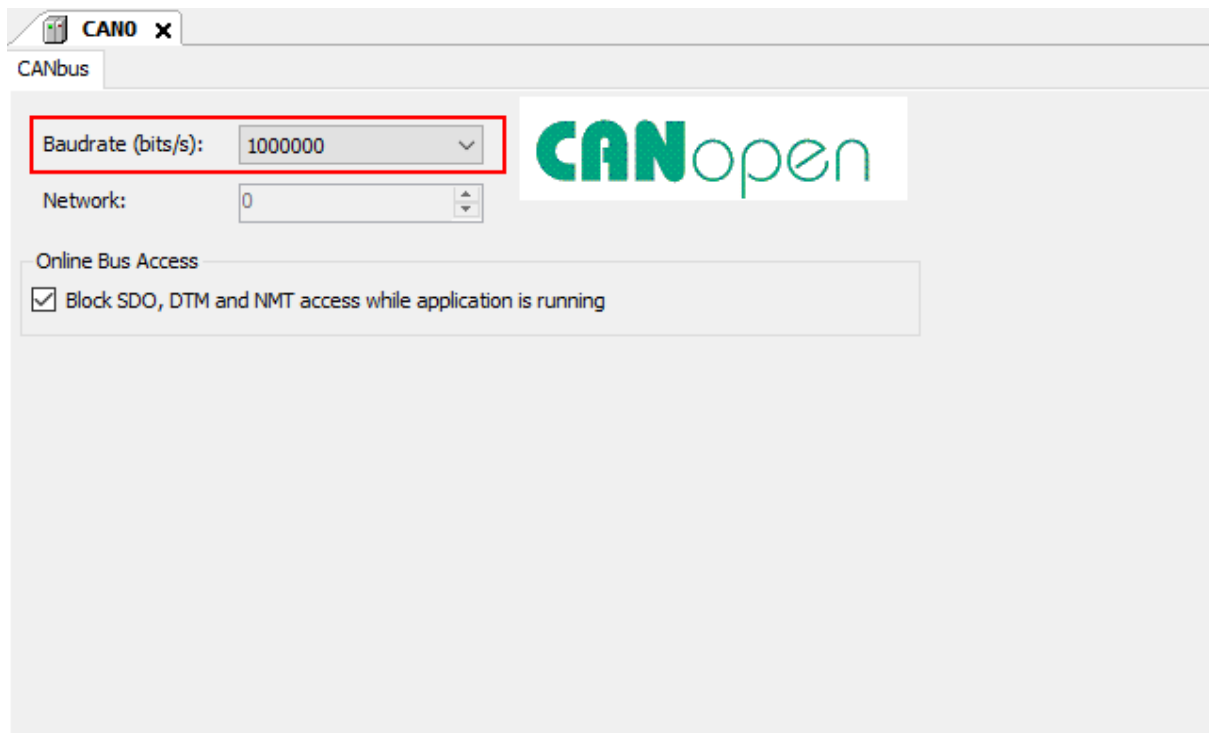

Note: Baud rate conversion: 1 Mbps=1000 Kbps=1000000bps

7.2.2 Importing EDS File of RTU-CN01

Start the SoMachine V4.1 software and import EDS file by clicking on “Tools” >> “Devices” >> “Install”. Select the EDS file to be added in the window. Afterward, click on “Open” button and then click on “Install” to install DTM (Device type manager)”.

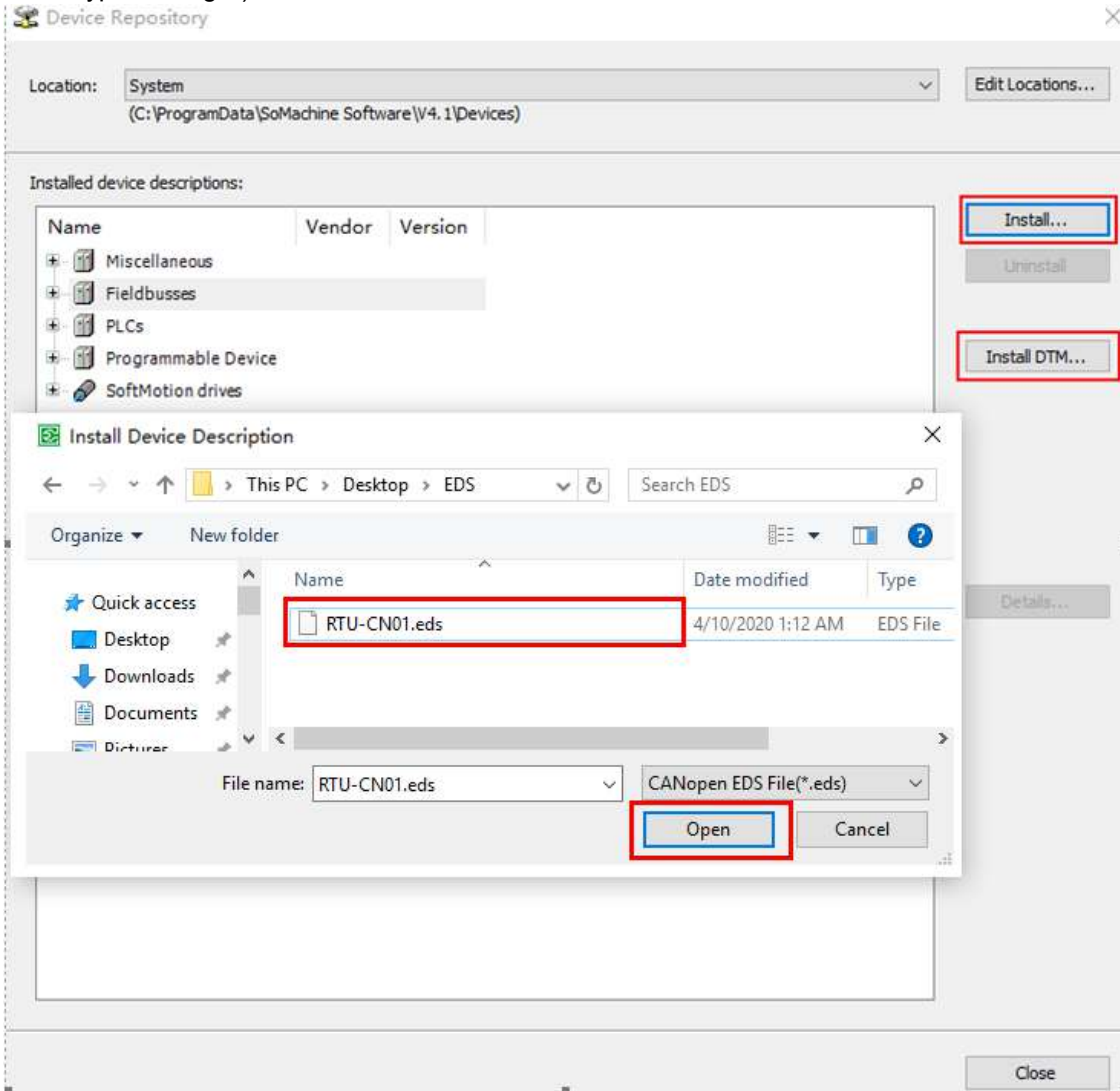

7

7.2.3 Adding the Remote Terminal RTU-CN01

Open the “Devices” window and then add RTU-CN01 in the way described below.

1. Right-click CAN0 and then select the “Add Device...” option from the context menu.

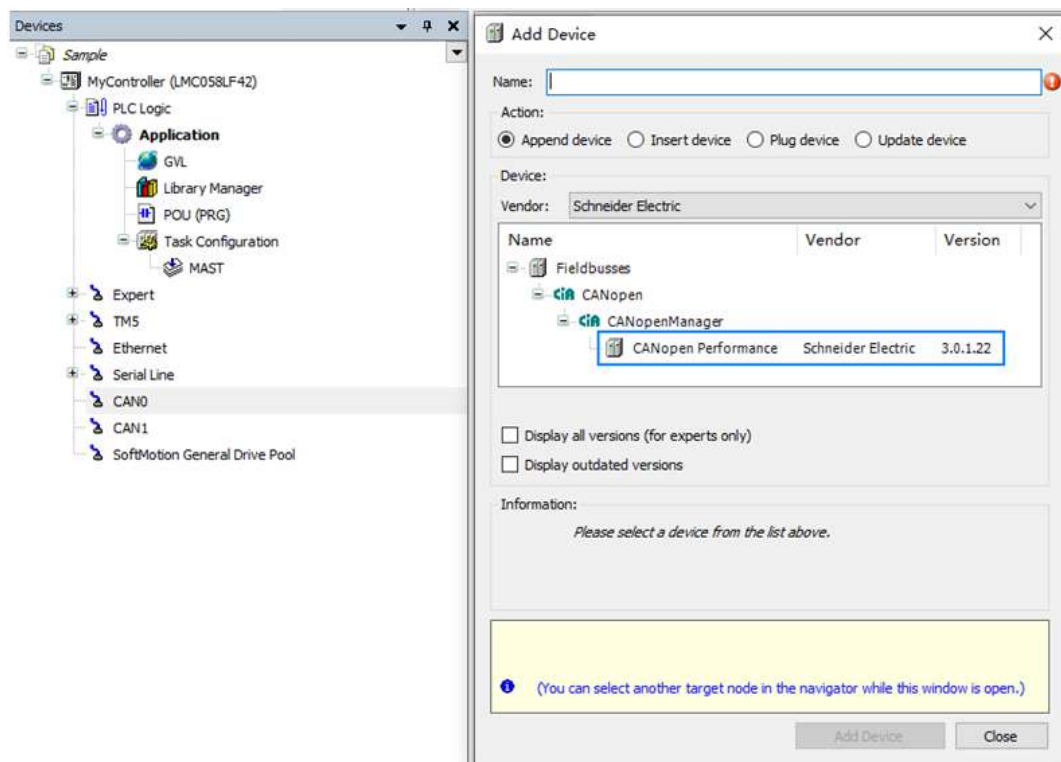
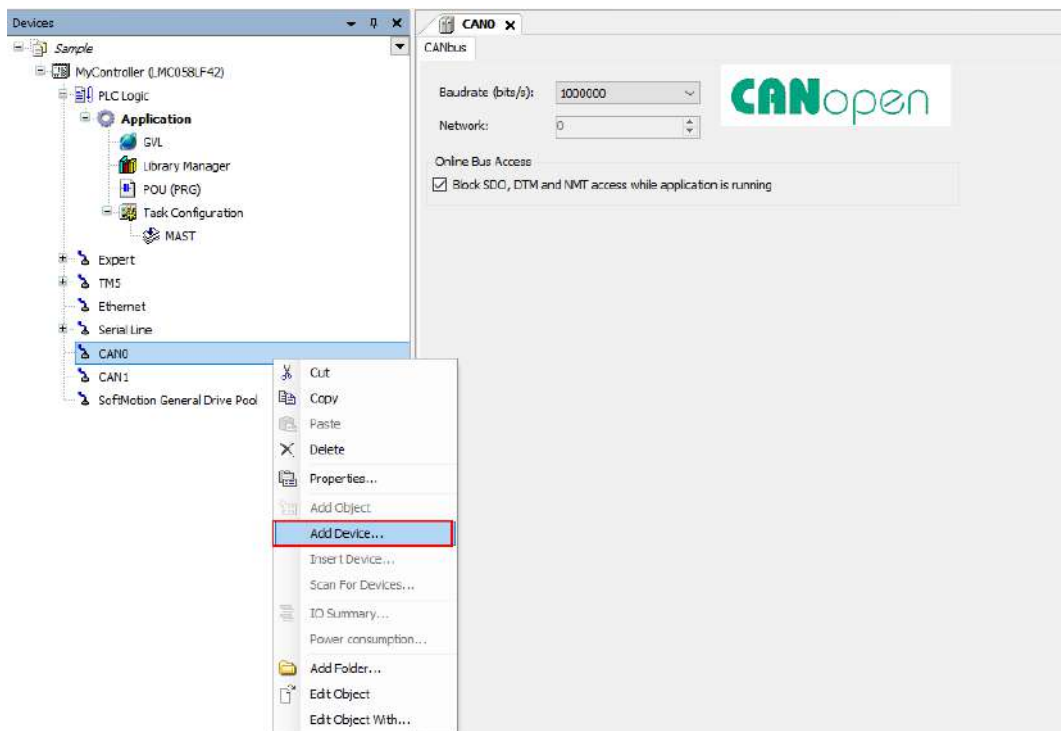

- Then the above window appears. Click “CANopen_Performance” and then “Add Device” button to add a device. Afterward the following window pops out once the device adding is done.

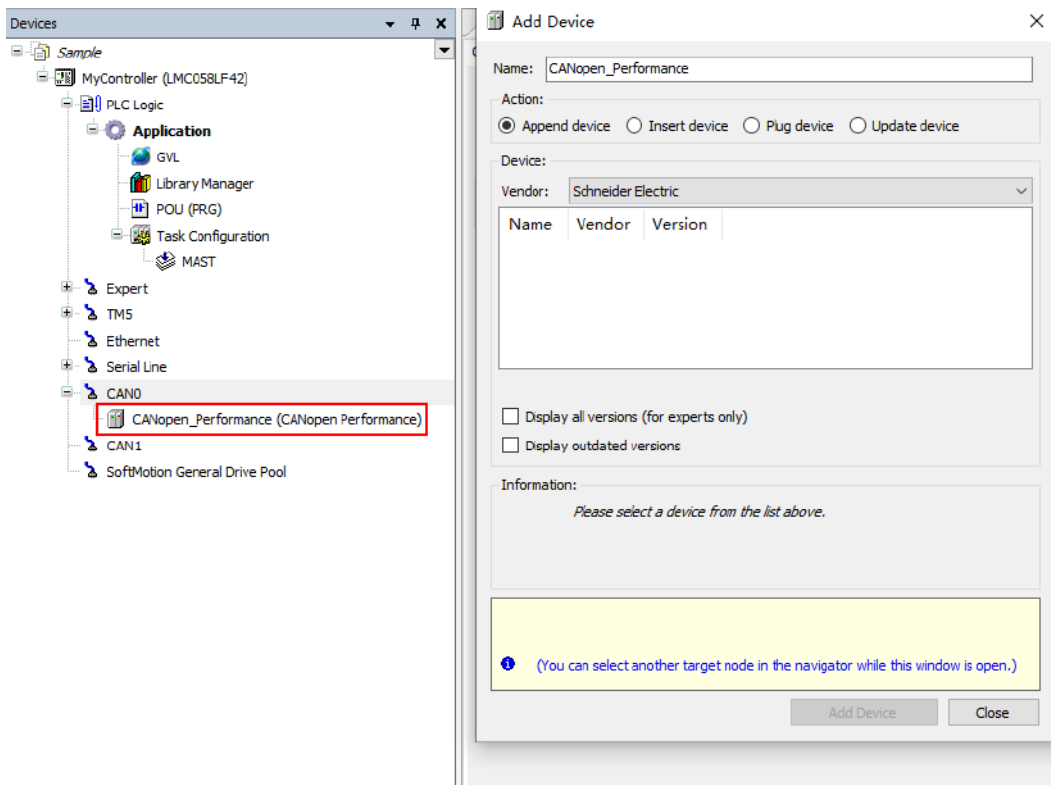

3. Click on the “CANopen_Performance” item from the “Devices” list on the left, select RTU-CN01 as the remote device, and then click “Add Device” button.

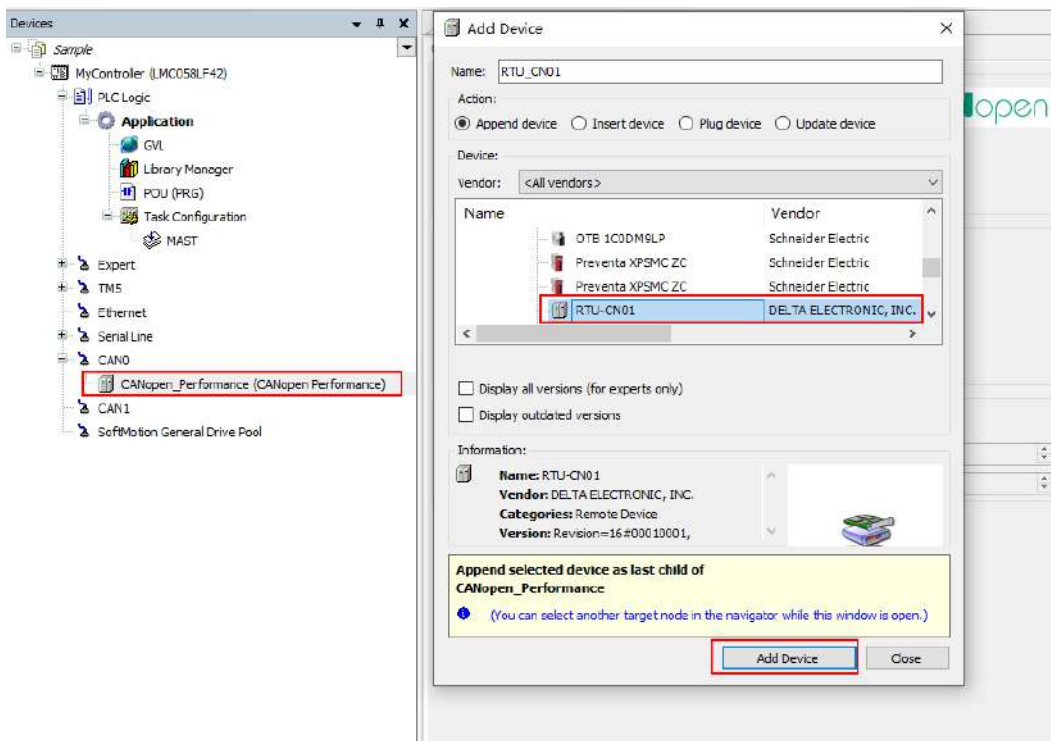

7

7.2.4 Configuring CANopen Remote Device Parameters

Here are the steps for configuring CANopen parameters:

With a double-click on RTU-CN01 icon, a new tab page appears. Select the checkbox on the left of “Enable Expert Settings” and meanwhile ensure that the node ID is the same as that of the actually connected CANopen slave.

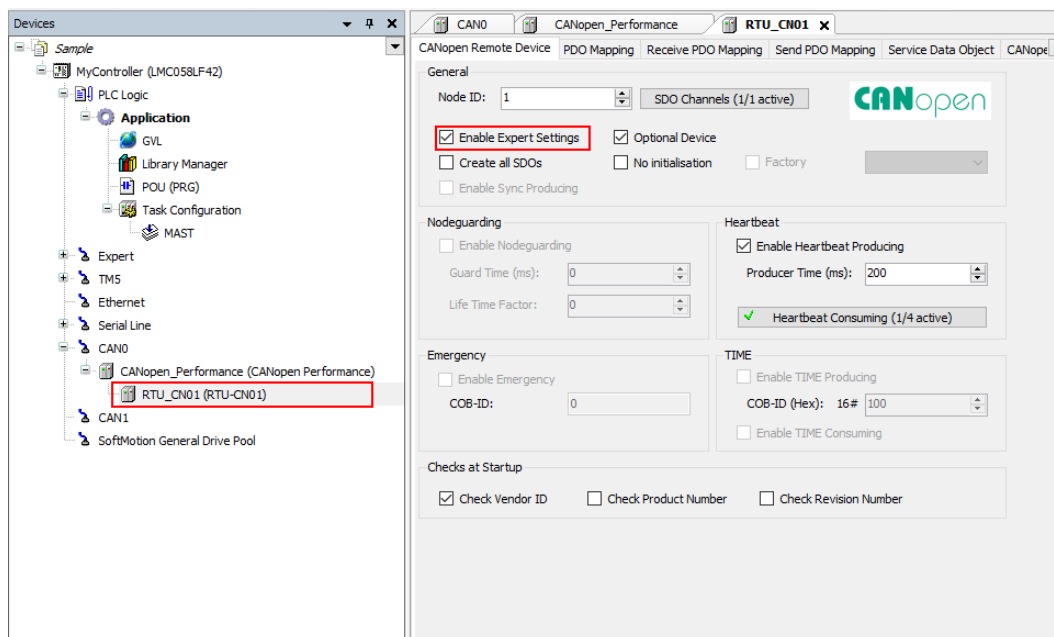

7.2.5 Configuring PDO Mappings

■ Receive PDO Mapping

With a click on the “Receive PDO Mapping” tab, the following interface appears. Select one desired Receive PDO, and then click "Add Mapping..." button there.

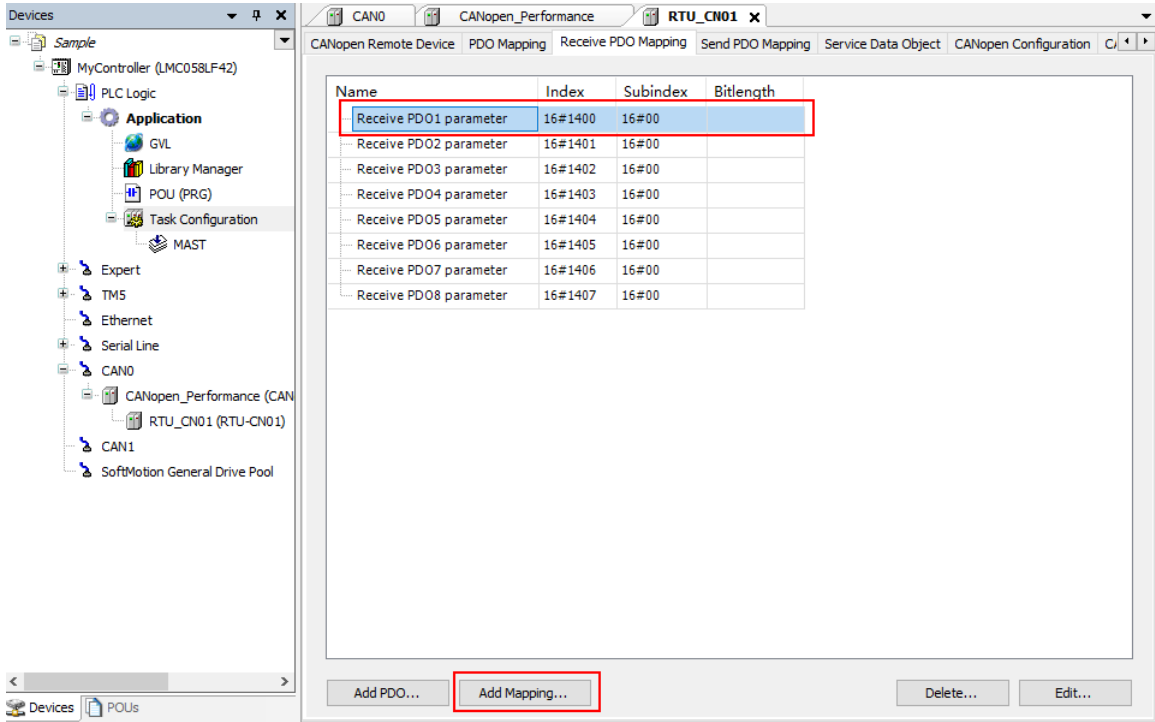

In the window which appears then, select RTU-CN01 parameters which need to be configured and configure them for Receive PDO by clicking “OK” button. Max. 8 bytes of data can be configured for each PDO.

For explanation of EDS file parameters, see Parameters from EDS File in Section 5.1.

Select item from object directory

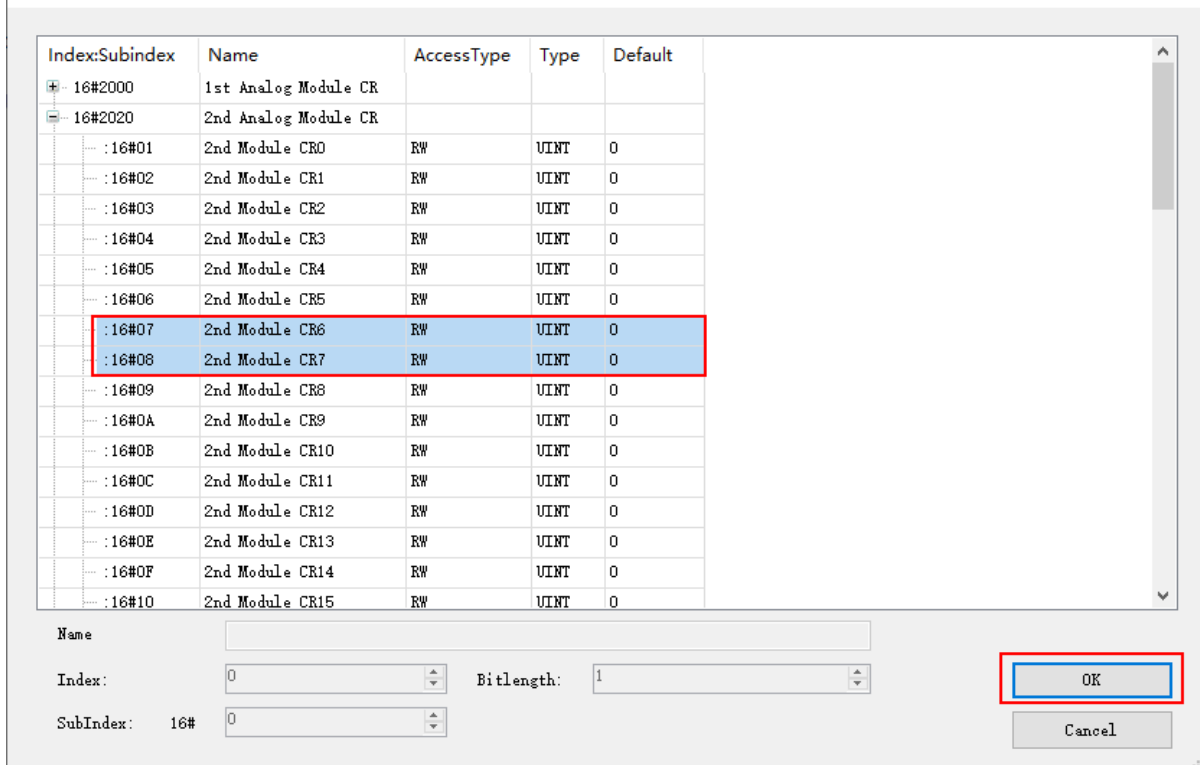

Index	Name	Access	Data Type	Start Bit
16#01	Digital8_out 1	RWW	USINT	16#0
16#02	Digital8_out 2	RWW	USINT	16#0
16#03	Digital8_out 3	RWW	USINT	16#0
16#04	Digital8_out 4	RWW	USINT	16#0
16#05	Digital8_out 5	RWW	USINT	16#0
16#06	Digital8_out 6	RWW	USINT	16#0
16#07	Digital8_out 7	RWW	USINT	16#0
16#08	Digital8_out 8	RWW	USINT	16#0

The complete configuration of Receive PDO mappings is as below.

CANopen Remote Device				PDO Mapping				Receive PDO Mapping				Send PDO Mapping				Service Data Object				CANopen Configuration			
Name	Index	Subindex	Bitlength																				
Receive PDO1 parameter	16#1400	16#00																					
2nd Module CR6	16#2020	16#07	16																				
2nd Module CR7	16#2020	16#08	16																				
Receive PDO2 parameter	16#1401	16#00																					
Digital8_out 1	16#6200	16#01	8																				
Receive PDO3 parameter	16#1402	16#00																					
Receive PDO4 parameter	16#1403	16#00																					
Receive PDO5 parameter	16#1404	16#00																					
Receive PDO6 parameter	16#1405	16#00																					
Receive PDO7 parameter	16#1406	16#00																					
Receive PDO8 parameter	16#1407	16#00																					

■ Send PDO Mapping

Here are the steps for configuring the Send PDO mappings.

Click “Send PDO Mapping” tab and select the desired Send PDO on the page. Then click “Add Mapping” button, select RTU-CN01 parameters which need to be configured and finally click “OK” button to finish the configuration of the parameters for Send PDO.

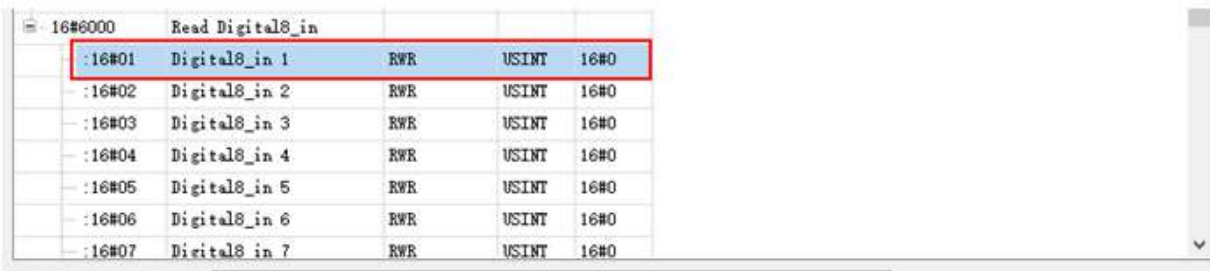
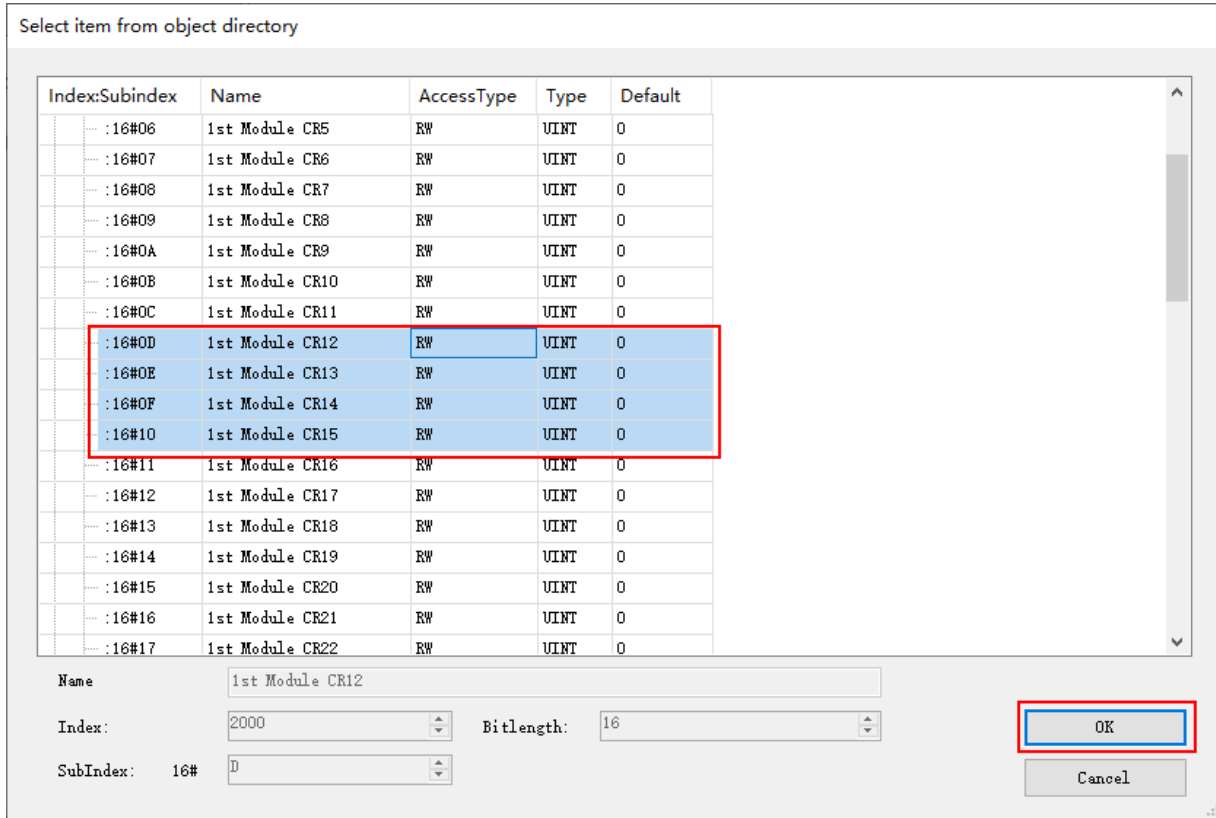

The complete configuration of Send PDO mappings is as below.

7

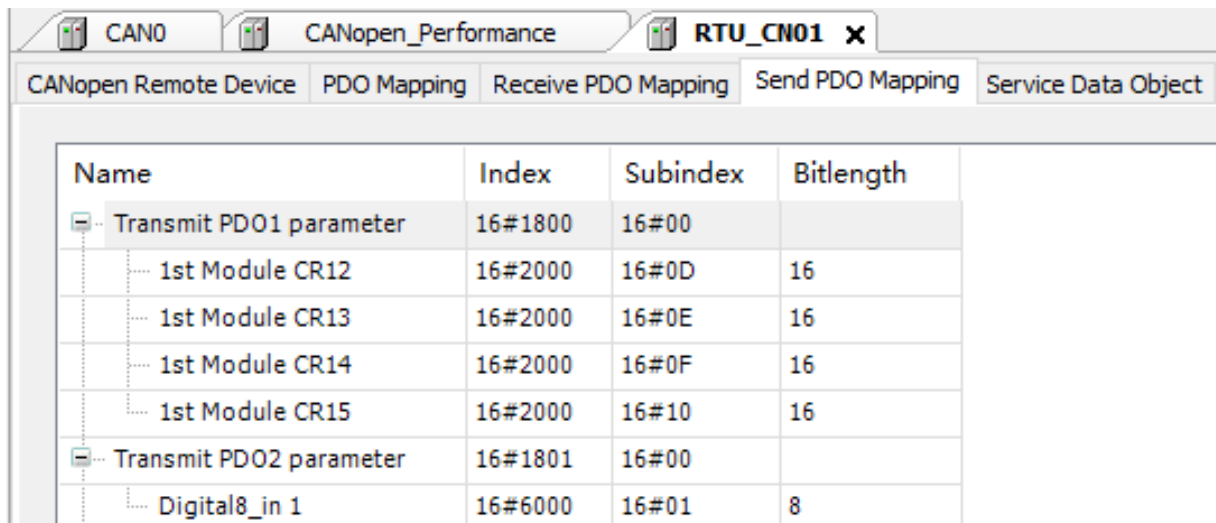

In this example, the input and output modes for DVP04AD-S and DVP04DA-S are default. Users can change the value of CR1 in special modules to choose the input and output modes of channels according to actual need. See section 5.2.4 for details.

■ PDO Mapping

After configuring the Receive PDO and Send PDO mappings, the following PDO mapping page appears with a click on “PDO Mapping” tab.

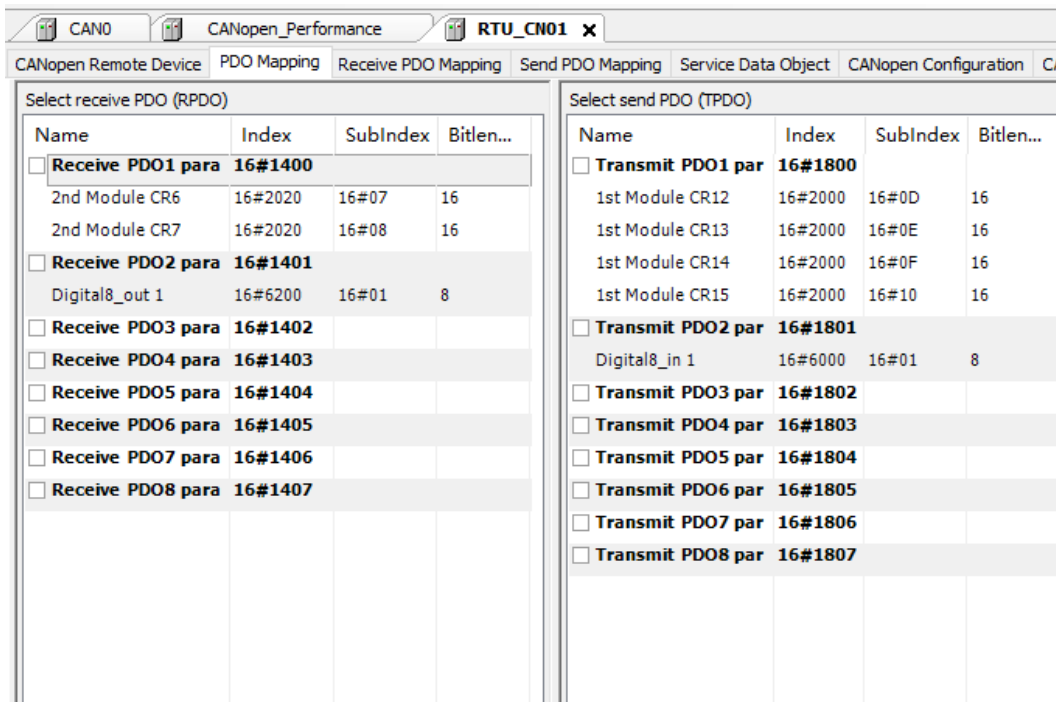

1. Configuring slave parameters to the master

Selecting the item in the red box below means that the slave PDO parameters are configured to the master. Not selecting the item in the red box below means that the slave PDO parameters are not configured to the master.

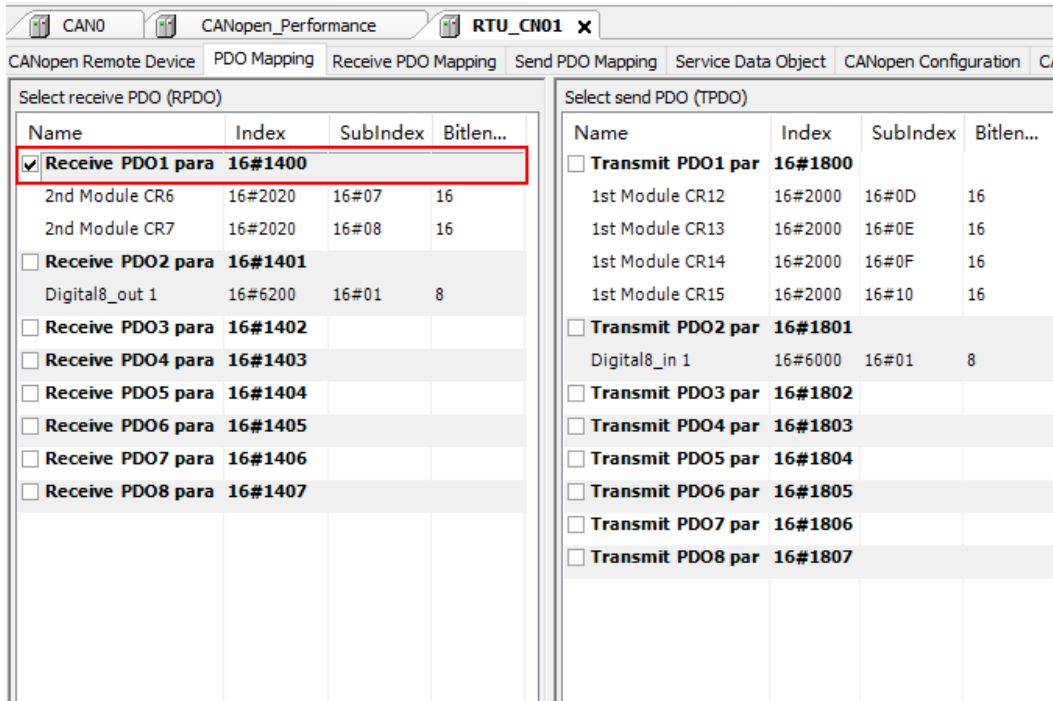

2. Setting PDO properties

The "PDO Properties" window appears by double-clicking the selected PDO on the above PDO Mapping page. Then select the transmission type of the PDO there.

Refer to Section 5.2 for details on PDO transmission type.

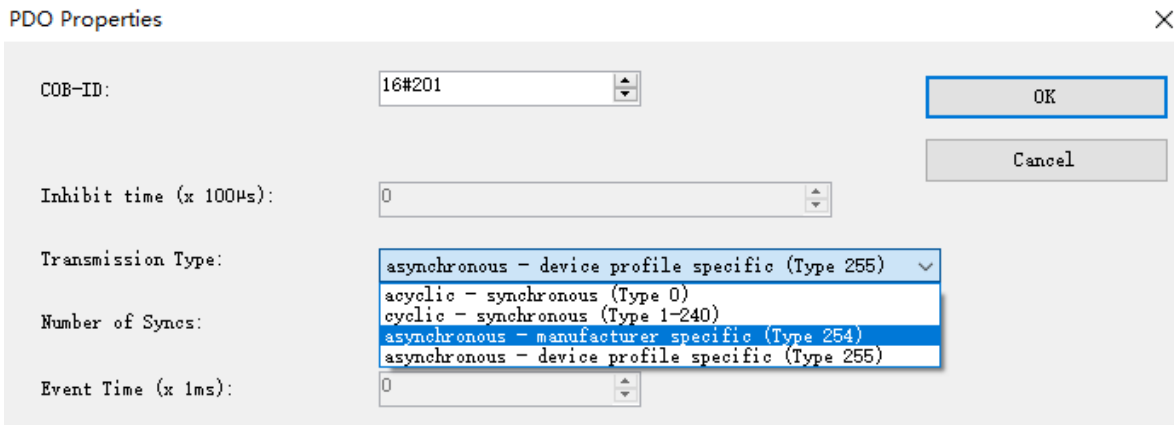

3. CANopen I/O Mapping

The following interface appears with a click on the "CANopen I/O Mapping" tab, where the configured parameters are displayed. Before using the configured parameters, type the variable names of the configured parameters to complete the mappings as shown in the red box below.

Variable	Mapping	Channel	Address	Type	Default Value	Unit	Description
RxVar1		2nd Module CR6	%QW2	UINT			
		2nd Module CR7	%QW3	UINT			
		Digital8_out 1	%QB8	USINT			
		1st Module CR12	%IW5	UINT			
		1st Module CR13	%IW6	UINT			
		1st Module CR14	%IW7	UINT			
		1st Module CR15	%IW8	UINT			
		Digital8_in 1	%IB18	USINT			

Note:

indicates the mappings have been completed. The addresses can not be operated straight in the third-party software like Schneider.

Below is the complete configuration of CANopen I/O mappings.

Variable	Mapping	Channel	Address	Type	Default Value	Unit	Description
RxVar1		2nd Module CR6	%QW2	UINT			
RxVa2		2nd Module CR7	%QW3	UINT			
RxVar3		Digital8_out 1	%QB8	USINT			
TxVar1		1st Module CR12	%IW5	UINT			
TxVar2		1st Module CR13	%IW6	UINT			
TxVar3		1st Module CR14	%IW7	UINT			
TxVar4		1st Module CR15	%IW8	UINT			
TxVar5		Digital8_in 1	%IB18	USINT			

The IO mappings between the controller and RTU-CN01 are as follows.

■ Controller → RTU-CN01 slave

Master variable name	CANopen bus data transmission	Slave parameter index	Slave parameter subindex	Slave parameter	Meaning of slave parameters
RxVar1		16#2020	16#7	CR6 of the 2 nd module on the right of RTU-CN01	DVP04DA's channel 1 setting value
RxVar2		16#2020	16#8	CR7 of the 2 nd module on the right of RTU-CN01	DVP04DA's channel 2 setting value
RxVar3		16#6200	16#1	8 points of digital output	DVP16SP's output Y0~Y7

■ RTU-CN01 slave → Controller

Master variable name	CANopen bus data transmission	Slave parameter index	Slave parameter subindex	Slave parameter	Meaning of slave parameters
TxVar1		16#2000	16#d	CR12 of the 1 st module on the right of RTU-CN01	DVP04AD's channel 1 present value
TxVar2		16#2000	16#e	CR13 of the 1 st module on the right of RTU-CN01	DVP04AD's channel 2 present value
TxVar3		16#2000	16#f	CR14 of the 1 st module on the right of RTU-CN01	DVP04AD's channel 3 present value
TxVar4		16#2000	16#10	CR15 of the 1 st module on the right of RTU-CN01	DVP04AD's channel 4 present value
TxVar5		16#6000	16#1	8 points of digital input	DVP16SP's input X0~X7

Chapter 8 Error Diagnosis and Trouble-shooting

Table of Contents

8.1 LED Indicator Diagnosis.....	8-2
8.2 Status Word Diagnosis.....	8-3
8.3 Software Diagnosis	8-5

RTU-CN01 provides three diagnostic methods, LED indicator diagnosis, status word diagnosis and software diagnosis.

8.1 LED Indicator Diagnosis

■ POWER LED

LED status	Indication	How to correct
Off	Power is abnormal.	Make sure that the supply power for RTU-CN01 works.
Green light on	Power is normal.	--

■ CAN RUN LED

LED status	Indication	How to correct
Green light in single flash	RTU-CN01 in STOP state	The upper computer is downloading the network configuration and RTU-CN01 is waiting until the download is complete.
Green light blinking	RTU-CN01 in Pre-operational state	<ol style="list-style-type: none"> 1. Check if the CANopen bus cable is wired properly. 2. Ensure that the baud rates of all nodes in the network are the same. 3. Check if the slaves configured in the software have acutally been connected to the network. 4. Check if some slave is offline.
Green light ON	RTU-CN01 in RUN state	--

■ CAN ERR LED

LED status	Indication	How to correct
Off	Normal	--
Red light in double flashes	Some slave is offline.	<ol style="list-style-type: none"> 1. Make sure that the CANopen bus cable is the standard cable. 2. Make sure that there is a terminal resistor at both ends of the CANopen bus.
Red light in single flash	The bus error exceeds the alert level.	<ol style="list-style-type: none"> 1. Make sure that the CANopen bus cable is the standard cable. 2. Make sure that there is a terminal resistor at both ends of the CANopen bus. 3. Check if there is too much interference around the CANopen bus cable.
Red light ON	Bus-off	<ol style="list-style-type: none"> 1. Check if the bus cable in the CANopen network is wired properly. 2. Ensure that the baud rates of all nodes in the network are the same and repower RTU-CN01.

■ RUN LED

LED status	Indication	How to correct
Green light ON	RTU-CN01 in RUN state	--
Off	RTU-CN01 in STOP state	Turn the switch to RUN
Blinking	The setting of the node address exceeds the allowed range.	Set the node address to a value between 1 and 127 by using the node address switch of RTU-CN01

■ ALARM LED

LED status	Indication	How to correct
Off	RTU-CN01 works normally or lacks the work power.	--
Red light blinking	<ol style="list-style-type: none"> The configuration data of RTU-CN01 is invalid; The extension modules on the right of RTU-CN01 are in error or fail to communicate with RTU-CN01. The setting of the node address exceeds the allowed range. 	<ol style="list-style-type: none"> Check if downloading the RTU-CN01 configuration is normal and re-download the RTU-CN01 configuration. Check if the modules on the right side of the RTU-CN01 are normal after obtaining relevant diagnostic information via the CANopen Builder software. Set the node address to a value between 1 and 127 by using the node address switch of RTU-CN01
Red light ON	<ol style="list-style-type: none"> Fatal errors or errors in the configuration data of RTU-CN01; RTU-CN01 is under voltage. 	<ol style="list-style-type: none"> Get relevant diagnostic information via the CANopen Builder software. Check the work power for RTU-CN01.

8.2 Status Word Diagnosis

The status word of RTU-CN01 is used to display the operating states of special modules and digital modules. Refer to Section 5.2.3 to learn details about the use of status word.

■ Status word diagnosis:

Bit	Status value	Indication	How to deal with
bit0	0	RTU-CN01 detected extension modules.	--
	1	RTU-CN01 failed to detect extension modules.	<ol style="list-style-type: none"> Check if there are extension modules on the right of RTU-CN01. Repower RTU-CN01
bit1	0	Extension modules connected to RTU-CN01 are consistent with the configuration data.	--

Bit	Status value	Indication	How to deal with
	1	Extension modules connected to RTU-CN01 are inconsistent with the configuration data.	Redownload the configuration data to RTU-CN01 by CANopen Builder.
bit2	0	No errors in special modules	--
	1	Some error occurs in special modules.	Check special modules.
bit3	0	Special modules works normally.	--
	1	Special module offline	Check special modules and repower RTU-CN01.
bit4	0	Valid configuration data	--
	1	Invalid configuration data	Redownload the configuration data to RTU-CN01 by CANopen Builder.
bit5	0	RTU-CN01 is working normally.	--
	1	The work power for RTU-CN01 is under voltage.	Check the power module for RTU-CN01.
bit6	0	RTU-CN01 is working normally.	--
	1	RTU-CN01 detectes some unrecognized special module.	Check if RTU-CN01 supports the special module.
bit7	0	RTU-CN01 is working normally.	--
	1	The number of special modules connected to RTU-CN01 exceeds 8 units or the number of digital IO points exceeds 128.	Remove the extra module.
bit8	0/1	Reserved	
bit9	0	RTU-CN01 in RUN state	--
	1	RTU-CN01 in STOP state	<ol style="list-style-type: none"> 1. Check the state of the RUN/STOP switch of RTU-CN01. 2. Check if H8000 was written to the control word of RTU-CN01. 3. Check if there is any fatal error in RTU-CN01

8.3 Software Diagnosis

In the main window of the RTU configuration, click the “Diagnostic” button to see relevant information in the “Diagnostics” area:

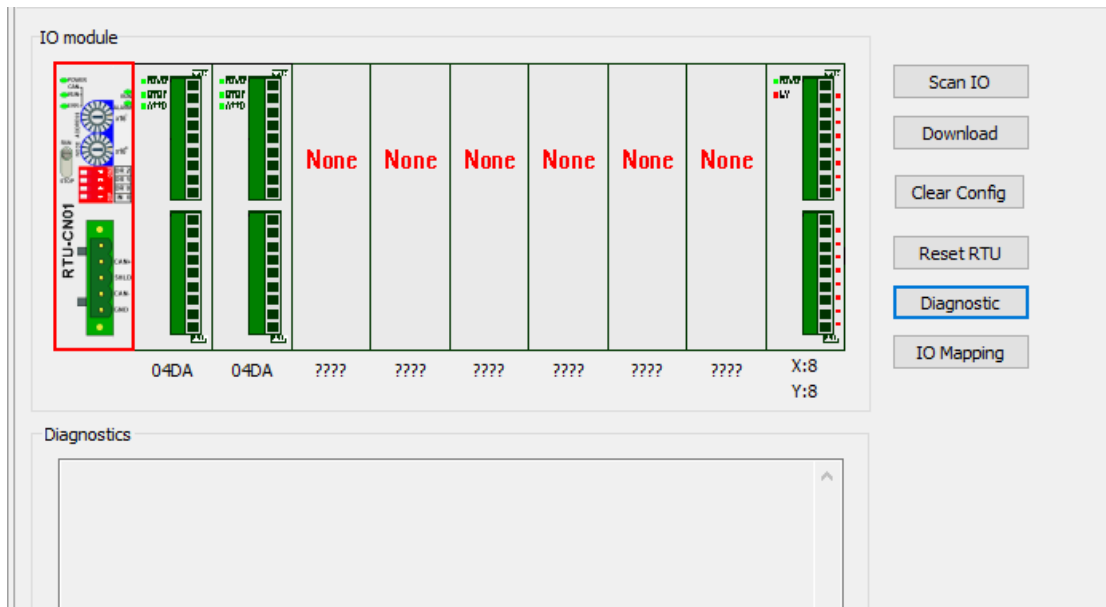

Note:

The software diagnostic function cannot start until the CANopen Builder software communicates with the controller normally. Otherwise the software will report the communication timeout message.

MEMO





Appendix A List of Accessories

Table of Contents

A.1 Accessories for CANopen Communication..... A-2

A.1 Accessories for CANopen Communication

- Cables

Figure	Model	Length	Diameter (AWG)
	UC-DN01Z-01A	305M	2#15 · 2#18 SHLD PVC (Thick cable)
	UC-DN01Z-02A	305M	2#22 · 2#24 SHLD PVC (Thin cable)
	UC-CMC003-01A	0.3M	4#26 · 1#24 PVC (Thin cable)
	UC-CMC005-01A	0.5M	4#26 · 1#24 PVC (Thin cable)
	UC-CMC010-01A	1.0M	4#26 · 1#24 PVC (Thin cable)
	UC-CMC015-01A	1.5M	4#26 · 1#24 PVC (Thin cable)
	UC-CMC020-01A	2.0M	4#26 · 1#24 PVC (Thin cable)
	UC-CMC030-01A	3.0M	4#26 · 1#24 PVC (Thin cable)
	UC-CMC050-01A	5.0M	4#26 · 1#24 PVC (Thin cable)
	UC-CMC100-01A	10.0M	4#26 · 1#24 PVC (Thin cable)
	UC-CMC200-01A	20.0M	4#26 · 1#24 PVC (Thin cable)

Notes:

1. The maximum cable length for purchase is 305M per reel and minimum length is 1M with metre as the unit.
2. UC-DN01Z-01A and UC-DN01Z-02A can be used as the main-line cable as well as the branch-line cable. The maximum communication distances that they support are different.

The maximum communication distances the two cables support at different CANopen transmission speed are displayed as follows.

CANopen transmission speed (bit/s)	125K	250K	500K	1M
Max. communication distance for UC-DN01Z-01A (m)	500	250	100	40
Max. communication distance for UC-DN01Z-02A (m)	100	100	100	40

3. The maximum communication distance at a transmission speed is regulated in the CANopen protocol. The relationships between maximum communication distances and transmission speeds are shown in the following table.

Transmission speed (bit/s)	10K	20K	50K	125K	250K	500K	800K	1M
Max. communication distance (m)	5000	2500	1000	500	250	100	50	40

● Distribution box

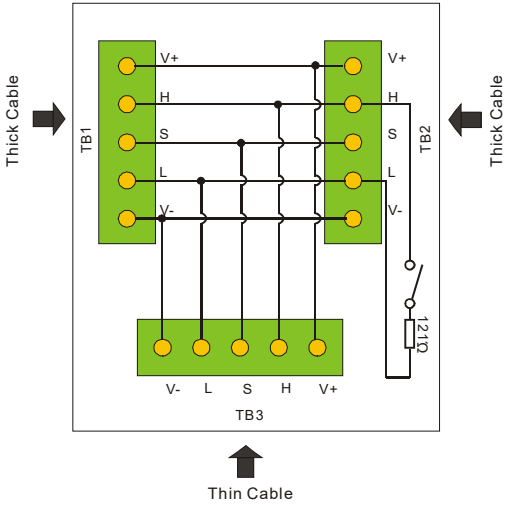
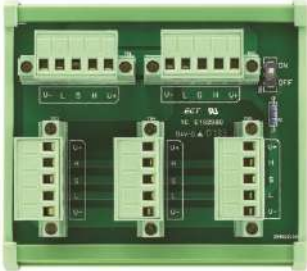
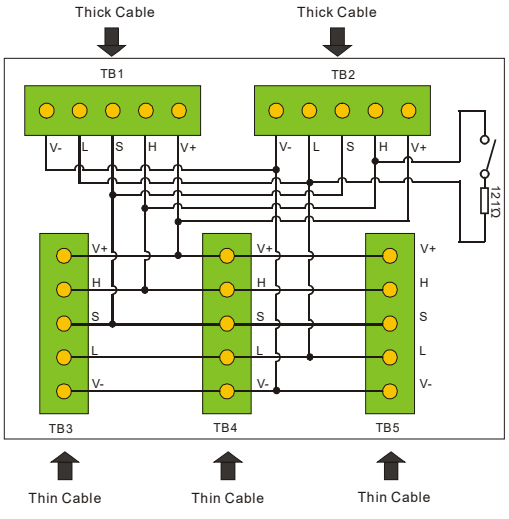
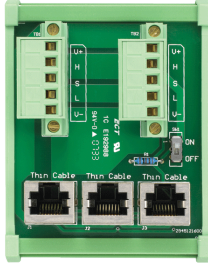
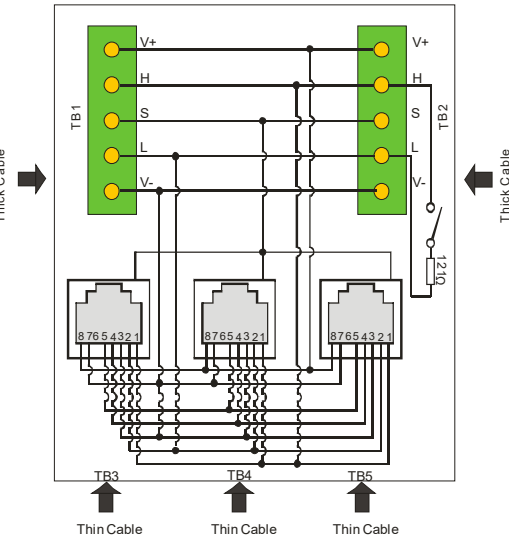
	Model	Circuit figure
TAP-CN01		
TAP-CN02		
TAP-CN03		
Connector	Removable terminals (5.08mm)	

A

	Model	Circuit figure
Terminal resistor		120Ω

● **Terminal resistor**

As suggested in the CANopen protocol, the two ends of the CANopen communication cable should connect a terminal resistor of 120Ω (1/4W) respectively in order to match the impedance of the communication signal and reduce the signal reflection interference in normal signal transmission.

- The terminal resistor connected to the start of the cable:
The terminal resistor on the distribution box can be used just by setting the terminal resistor switch to ON.
- The terminal resistor connected to the terminal end of the cable:
A terminal resistor TAP-TR01 is needed for connecting to the other end of the cable.
- The model of a terminal resistor: TAP-TR01, resistance value: 120Ω (1/4W) as shown below

